

**S21A**

(May 2011)

(Corr.1)

Oct 2011)

(Rev.1

May 2015)

(Corr.1

Feb 2018)

(Corr.2Mar 2019)

# Requirements concerning STRENGTH OF SHIPS

## S21A

### Evaluation of Scantlings of Hatch Covers and Hatch Coamings and Closing Arrangements of Cargo Holds of Ships

---

**Notes:**

1. This UR applies for ships contracted for construction on or after 1 July 2012.
2. Rev.1 of this UR applies for ships contracted for construction on or after 1 July 2016.
3. The “contracted for construction” date means the date on which the contract to build the vessel is signed between the prospective owner and the shipbuilder. For further details regarding the date of “contract for construction”, refer to IACS Procedural Requirement (PR) No. 29.

**S21A**  
(cont)**1 Application and definitions****1.1 Application**

These requirements apply to all ships except bulk carriers, self-unloading bulk carriers, ore carriers and combination carriers, as defined in UR Z11, and are for all cargo hatch covers and coamings on exposed decks.

The strength requirements are applicable to hatch covers and hatch coamings of stiffened plate construction and its closing arrangements.

This UR is applicable to hatch covers and coamings made of steel. In case of alternative materials and innovative designs the approval is subject to the individual class society.

This UR does not apply to portable covers secured weathertight by tarpaulins and battening devices, or pontoon covers, as defined in ICLL Regulation 15.

These requirements are in addition to the requirements of the ICLL.

**1.2 Definitions**

ICLL Where ICLL is referred to in the text, this is to be taken as the International Convention on Load Lines, 1966 as amended by the 1988 protocol, as amended in 2003.

**1.2.1 Hatch cover types****• Single skin cover**

A hatch cover made of steel or equivalent material that is designed to comply with ICLL Regulation 16. The cover has continuous top and side plating, but is open underneath with the stiffening structure exposed. The cover is weathertight and fitted with gaskets and clamping devices unless such fittings are specifically excluded.

**• Double skin cover**

A hatch cover as above but with continuous bottom plating such that all the stiffening structure and internals are protected from the environment.

**• Pontoon type cover**

A special type of portable cover, secured weathertight by tarpaulins and battening devices. Such covers are to be designed in accordance with ICLL Regulation 15 and are not covered by this UR.

**Clarification note:**

Modern hatch cover designs of lift-away-covers are in many cases called pontoon covers. This definition does not fit to the definition above. Modern lift-away hatch cover designs should belong to one of the two categories-single skin covers or double skin cover.

**S21A**  
(cont)**1.2.2 Positions**

The hatchways are classified according to their position as follows:

Position 1 Upon exposed freeboard and raised quarterdecks, and upon exposed superstructure decks situated forward of a point located a quarter of ship's length from forward perpendicular.

Position 2 Upon exposed superstructure decks situated abaft a quarter of the ship's length from the forward perpendicular and located at least one standard height of the superstructure above the freeboard deck.

Upon exposed superstructure decks situated forward of a point located a quarter of the ship's length from the forward perpendicular and located at least two standard height of the superstructure above the freeboard deck.

**1.3 Material**

Hatch covers and coamings are to be made of material in accordance with the definitions of UR S6. Material class I is to be applied for top plate, bottom plate and primary supporting members.

**1.4 General requirements**

Primary supporting members and secondary stiffeners of hatch covers are to be continuous over the breadth and length of hatch covers, as far as practical. When this is impractical, sniped end connections are not to be used and appropriate arrangements are to be adopted to provide sufficient load carrying capacity.

The spacing of primary supporting members parallel to the direction of secondary stiffeners is not to exceed 1/3 of the span of primary supporting members. When strength calculation is carried out by FE analysis using plane strain or shell elements, this requirement can be waived.

Secondary stiffeners of hatch coamings are to be continuous over the breadth and length of hatch coamings.

**1.5 Net scantling approach**

Unless otherwise quoted, the thicknesses  $t$  of the following sections are net thicknesses.

The net thicknesses are the member thicknesses necessary to obtain the minimum net scantlings required by 3 and 5.

The required gross thicknesses are obtained by adding corrosion additions,  $t_s$ , given in Tab.10 in 7.1.

Strength calculations using grillage analysis or FEM are to be performed with net scantlings.

# S21A

(cont)

## 2 Hatch cover and coaming load model

Structural assessment of hatch covers and hatch coamings is to be carried out using the design loads, defined in this chapter.

### Definitions

- L = length of ship, in m, as defined in UR S2  
 $L_{LL}$  = length of ship, in m, as defined in ICLL Regulation 3  
 $x$  = longitudinal co-ordinate of mid point of assessed structural member measured from aft end of length L or  $L_{LL}$ , as applicable  
 $D_{min}$  = the least moulded depth, in m, as defined in ICLL Regulation 3  
 $h_N$  = standard superstructure height in m  
 $= 1,05 + 0,01 L_{LL}$ ,  $1,8 \leq h_N \leq 2,3$

### 2.1 Vertical weather design load

The pressure  $p_H$ , in kN/m<sup>2</sup>, on the hatch cover panels is given by ICLL. This may be taken from Tab.1. The vertical weather design load needs not to be combined with cargo loads according to 2.3 and 2.4.

In Fig.1 the positions 1 and 2 are illustrated for an example ship.

Where an increased freeboard is assigned, the design load for hatch covers according to Tab.1 on the actual freeboard deck may be as required for a superstructure deck, provided the summer freeboard is such that the resulting draught will not be greater than that corresponding to the minimum freeboard calculated from an assumed freeboard deck situated at a distance at least equal to the standard superstructure height  $h_N$  below the actual freeboard deck, see Fig.2.

Tab. 1. Design load  $p_H$  of weather deck hatchesS21A  
(cont)

Position	Design load $p_H$ [kN/m <sup>2</sup> ]	
	$\frac{x}{L_{LL}} \leq 0,75$	$0,75 < \frac{x}{L_{LL}} \leq 1,0$
1	for $24 \text{ m} \leq L_{LL} \leq 100 \text{ m}$	
	$\frac{9,81}{76} \cdot (1,5 \cdot L_{LL} + 116)$	on freeboard deck $\frac{9,81}{76} \cdot \left[ (4,28 \cdot L_{LL} + 28) \cdot \frac{x}{L_{LL}} - 1,71 \cdot L_{LL} + 95 \right]$
		upon exposed superstructure decks located at least one superstructure standard height above the freeboard deck $\frac{9,81}{76} \cdot (1,5 \cdot L_{LL} + 116)$
	for $L_{LL} > 100 \text{ m}$	
	$9,81 \cdot 3,5$	on freeboard deck for type B ships according to ICLL $9,81 \cdot \left[ (0,0296 \cdot L_1 + 3,04) \cdot \frac{x}{L_{LL}} - 0,0222 \cdot L_1 + 1,22 \right]$
		on freeboard deck for ships with less freeboard than type B according to ICLL $9,81 \cdot \left[ (0,1452 \cdot L_1 - 8,52) \cdot \frac{x}{L_{LL}} - 0,1089 \cdot L_1 + 9,89 \right]$ $L_1 = L_{LL}$ but not more than 340 m
upon exposed superstructure decks located at least one superstructure standard height above the freeboard deck $9,81 \cdot 3,5$		
2	for $24 \text{ m} \leq L_{LL} \leq 100 \text{ m}$	
	$\frac{9,81}{76} \cdot (1,1 \cdot L_{LL} + 87,6)$	
	for $L_{LL} > 100 \text{ m}$	
	$9,81 \cdot 2,6$	
upon exposed superstructure decks located at least one superstructure standard height above the lowest Position 2 deck $9,81 \cdot 2,1$		

# S21A

(cont)

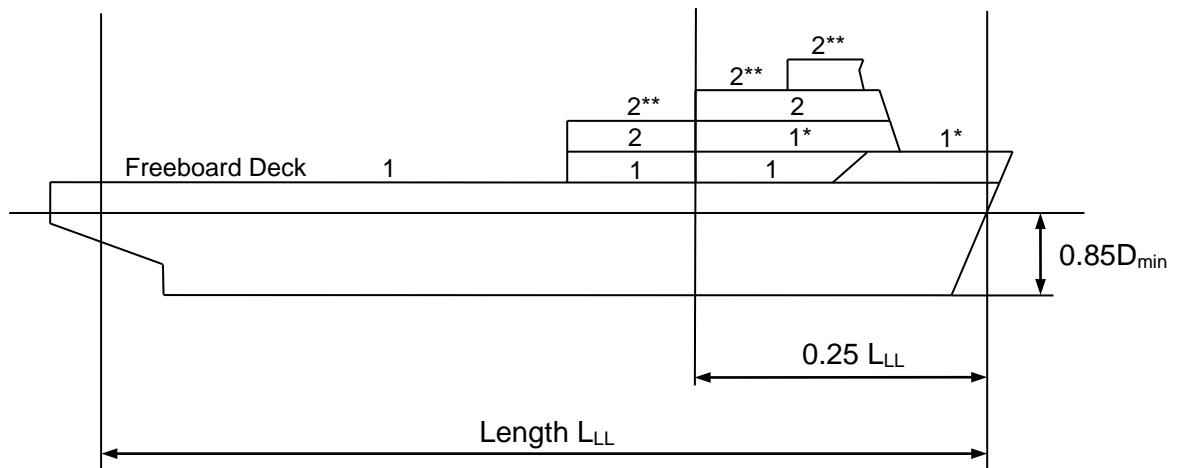

- \* reduced load upon exposed superstructure decks located at least one superstructure standard height above the freeboard deck
- \*\* reduced load upon exposed superstructure decks of vessels with  $L_{LL} > 100$  m located at least one superstructure standard height above the lowest Position 2 deck

**Fig. 1.Positions 1 and 2**

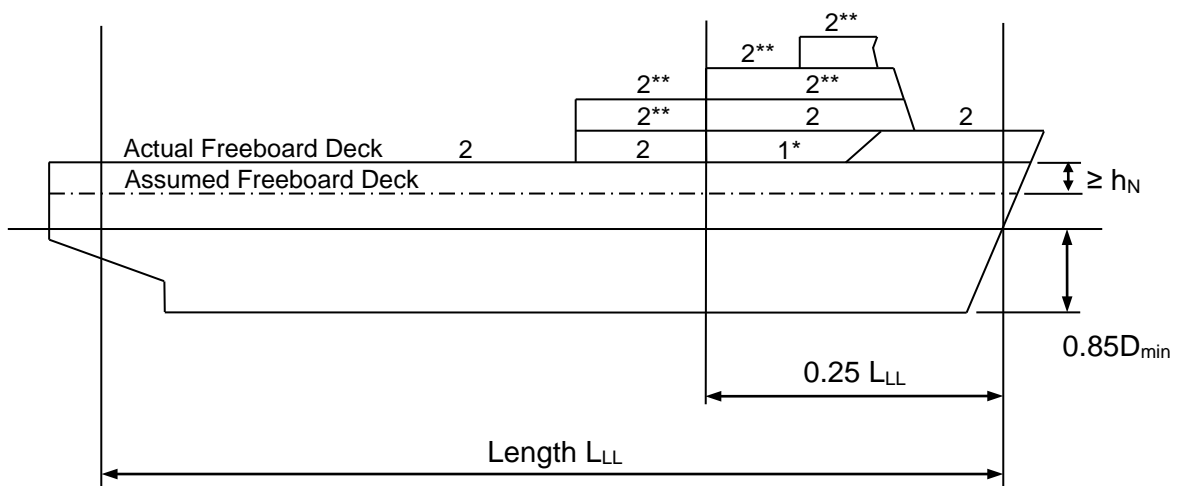

- \* reduced load upon exposed superstructure decks located at least one superstructure standard height above the freeboard deck
- \*\* reduced load upon exposed superstructure decks of vessels with  $L_{LL} > 100$  m located at least one superstructure standard height above the lowest Position 2 deck

**Fig. 2.Positions 1 and 2 for an increased freeboard**

# S21A

(cont)

## 2.2 Horizontal weather design load

The horizontal weather design load, in kN/m<sup>2</sup>, for determining the scantlings of outer edge girders (skirt plates) of weather deck hatch covers and of hatch coamings is:

$$p_A = a \cdot c \cdot (b \cdot c_L \cdot f - z)$$

$$f = \frac{L}{25} + 4,1 \quad \text{for } L < 90 \text{ m}$$

$$= 10,75 - \left( \frac{300 - L}{100} \right)^{1,5} \quad \text{for } 90 \text{ m} \leq L < 300 \text{ m}$$

$$= 10,75 \quad \text{for } 300 \text{ m} \leq L < 350 \text{ m}$$

$$= 10,75 - \left( \frac{L - 350}{150} \right)^{1,5} \quad \text{for } 350 \text{ m} \leq L \leq 500 \text{ m}$$

$$c_L = \sqrt{\frac{L}{90}} \quad \text{for } L < 90 \text{ m}$$

$$= 1 \quad \text{for } L \geq 90 \text{ m}$$

$$a = 20 + \frac{L_1}{12} \quad \text{for unprotected front coamings and hatch cover skirt plates}$$

$$a = 10 + \frac{L_1}{12} \quad \text{for unprotected front coamings and hatch cover skirt plates, where the distance from the actual freeboard deck to the summer load line exceeds the minimum non-corrected tabular freeboard according to ICLL by at least one standard superstructure height } h_N$$

$$a = 5 + \frac{L_1}{15} \quad \text{for side and protected front coamings and hatch cover skirt plates}$$

$$a = 7 + \frac{L_1}{100} - 8 \cdot \frac{x'}{L} \quad \text{for aft ends of coamings and aft hatch cover skirt plates abaft amidships}$$

$$a = 5 + \frac{L_1}{100} - 4 \cdot \frac{x'}{L} \quad \text{for aft ends of coamings and aft hatch cover skirt plates forward of amidships}$$

$$L_1 = L, \text{ need not be taken greater than } 300 \text{ m}$$

$$b = 1,0 + \left( \frac{\frac{x'}{L} - 0,45}{C_B + 0,2} \right)^2 \quad \text{for } \frac{x'}{L} < 0,45$$

$$= 1,0 + 1,5 \cdot \left( \frac{\frac{x'}{L} - 0,45}{C_B + 0,2} \right)^2 \quad \text{for } \frac{x'}{L} \geq 0,45$$

$0,6 \leq C_B \leq 0,8$ , when determining scantlings of aft ends of coamings and aft hatch cover skirt plates forward of amidships,  $C_B$  need not be taken less than 0,8.

## S21A (cont)

- $x'$  = distance in m between the transverse coaming or hatch cover skirt plate considered and aft end of the length  $L$ . When determining side coamings or side hatch cover skirt plates, the side is to be subdivided into parts of approximately equal length, not exceeding  $0,15 L$  each, and  $x'$  is to be taken as the distance between aft end of the length  $L$  and the centre of each part considered.
- $z$  = vertical distance in m from the summer load line to the midpoint of stiffener span, or to the middle of the plate field
- $c$  =  $0,3 + 0,7 \cdot \frac{b'}{B'}$
- $b'$  = breadth of coaming in m at the position considered
- $B'$  = actual maximum breadth of ship in m on the exposed weather deck at the position considered.

$b'/B'$  is not to be taken less than 0,25.

The design load  $p_A$  is not to be taken less than the minimum values given in Tab.2.

**Tab.2 Minimum design load  $p_{Amin}$**

L	$P_{Amin}$ in kN/m <sup>2</sup> for	
	unprotected fronts	elsewhere
$\leq 50$	30	15
$> 50$	$25 + \frac{L}{10}$	$12,5 + \frac{L}{20}$
$< 250$		
$\geq 250$	50	25

**Note:**

The horizontal weather design load need not be included in the direct strength calculation of the hatch cover, unless it is utilized for the design of substructures of horizontal support according to 6.2.3.

### 2.3 Cargo loads

#### 2.3.1 Distributed loads

The load on hatch covers due to distributed cargo loads  $P_L$ , in kN/m<sup>2</sup>, resulting from heave and pitch (i.e. ship in upright condition) is to be determined according to the following formula:

$$p_L = p_C (1 + a_v)$$



## S21A (cont)

where:

$p_C$  = uniform cargo load in kN/m<sup>2</sup>

$a_v$  = vertical acceleration addition as follows:

$$a_v = F \cdot m$$

$$F = 0,11 \cdot \frac{v_0}{\sqrt{L}}$$

$$m = m_0 - 5(m_0 - 1) \frac{x}{L} \quad \text{for } 0 \leq \frac{x}{L} \leq 0,2$$

$$= 1,0 \quad \text{for } 0,2 < \frac{x}{L} \leq 0,7$$

$$= 1 + \frac{m_0 + 1}{0,3} \left[ \frac{x}{L} - 0,7 \right] \quad \text{for } 0,7 < \frac{x}{L} \leq 1,0$$

$$m_0 = 1,5 + F$$

$v_0$  = maximum speed at summer load line draught,  $v_0$  is not to be taken less than  $\sqrt{L}$  in knots

### 2.3.2 Point loads

The load  $P$ , in kN, due to a concentrated force  $P_s$ , in kN, except for container load, resulting from heave and pitch (i.e. ship in upright condition) is to be determined as follows:

$$P = P_s (1 + a_v)$$

## 2.4 Container loads

### 2.4.1

The loads defined in 2.4.2 and 2.4.4 are to be applied where containers are stowed on the hatch cover.

### 2.4.2

The load  $P$  in kN, applied at each corner of a container stack, and resulting from heave and pitch (i.e. ship in upright condition) is to be determined as follows:

$$P = 9,81 \frac{M}{4} (1 + a_v)$$

where:

$a_v$  = acceleration addition according to 2.3.1

$M$  = maximum designed mass of container stack in t

**S21A**

(cont)

**2.4.3**

The loads, in kN, applied at each corner of a container stack, and resulting from heave, pitch, and the ship's rolling motion (i.e. ship in heel condition) are to be determined as follows, (see also Fig.3):

$$A_z = 9,81 \frac{M}{2} \cdot (1 + a_v) \cdot \left( 0,45 - 0,42 \frac{h_m}{b} \right)$$

$$B_z = 9,81 \frac{M}{2} \cdot (1 + a_v) \cdot \left( 0,45 + 0,42 \frac{h_m}{b} \right)$$

$$B_y = 2,4 \cdot M$$

where:

$a_v$  = acceleration addition according to 2.3.1

$M$  = maximum designed mass of container stack in t  
 $= \sum W_i$

$h_m$  = designed height of centre of gravity of stack above hatch cover top in m,  
 may be calculated as weighted mean value of the stack, where the centre of gravity of each tier is assumed to be located at the centre of each container,  
 $= \sum (z_i \cdot W_i) / M$

$z_i$  = distance from hatch cover top to the centre of  $i$ th container in m

$W_i$  = weight of  $i$ th container in t

$b$  = distance between midpoints of foot points in m

$A_z, B_z$  = support forces in z-direction at the forward and aft stack corners

$B_y$  = support force in y-direction at the forward and aft stack corners

When strength of the hatch cover structure is assessed by grillage analysis according to 3.5,  $h_m$  and  $z_i$  need to be taken above the hatch cover supports. Forces  $B_y$  does not need to be considered in this case.

Values of  $A_z$  and  $B_z$  applied for the assessment of hatch cover strength are to be shown in the drawings of the hatch covers.

**Note:**

*It is recommended that container loads as calculated above are considered as limit for foot point loads of container stacks in the calculations of cargo securing (container lashing).*

## S21A

(cont)

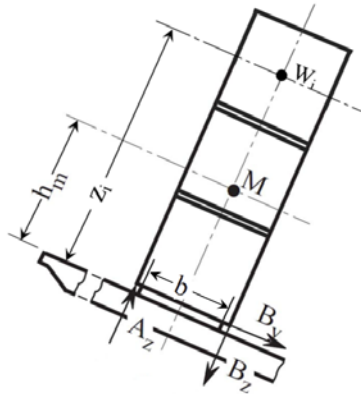

**Fig. 3 Forces due to container loads**

### 2.4.4 Load cases with partial loading

The load cases defined in 2.4.2 and 2.4.3 are also to be considered for partial non homogeneous loading which may occur in practice, e.g. where specified container stack places are empty. For each hatch cover, the heel directions, as shown in Tab. 3, are to be considered.

The load case *partial loading of container hatch covers* can be evaluated using a simplified approach, where the hatch cover is loaded without the outermost stacks that are located completely on the hatch cover. If there are additional stacks that are supported partially by the hatch cover and partially by container stanchions then the loads from these stacks are also to be neglected, refer to Tab.3. Partial loading of container hatch covers.

In addition, the case where only the stack places supported partially by the hatch cover and partially by container stanchions are left empty is to be assessed in order to consider the maximum loads in the vertical hatch cover supports.

It may be necessary to also consider partial load cases where more or different container stack places are left empty. Therefore, a classification society may require that additional partial load cases be considered.

Tab.3 Partial loading of container hatch covers

S21A  
(cont)

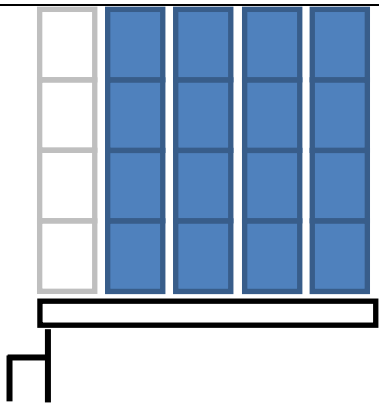
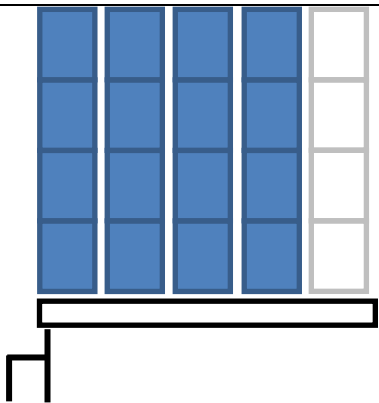
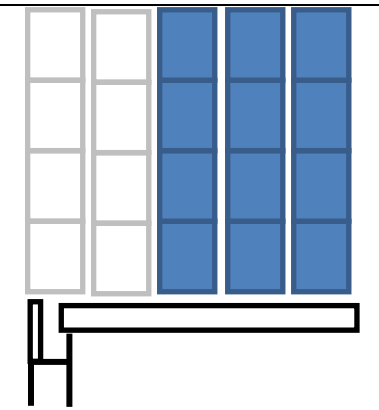
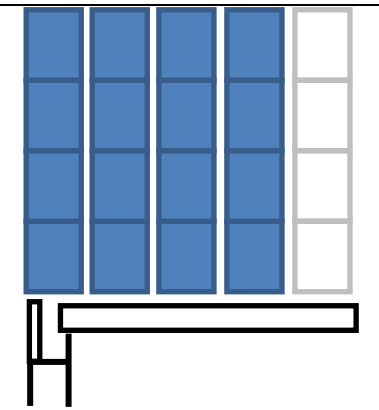
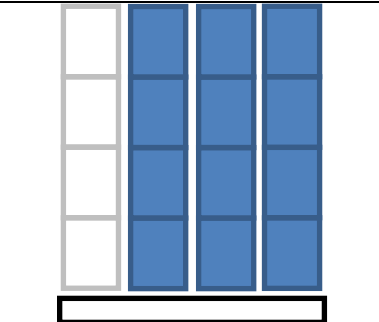
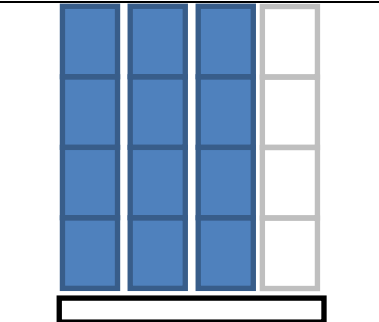
Heel direction	←	→
Hatch covers supported by the longitudinal hatch coaming with all container stacks located completely on the hatch cover		
Hatch covers supported by the longitudinal hatch coaming with the outermost container stack supported partially by the hatch cover and partially by container stanchions		
Hatch covers not supported by the longitudinal hatch coaming (center hatch covers)		

#### 2.4.5 Mixed stowage of 20' and 40' containers on hatch cover

In the case of mixed stowage (20'+40' container combined stack), the foot point forces at the fore and aft end of the hatch cover are not to be higher than resulting from the design stack weight for 40' containers, and the foot point forces at the middle of the cover are not to be higher than resulting from the design stack weight for 20' containers.

#### 2.5 Loads due to elastic deformations of the ship's hull

Hatch covers, which in addition to the loads according to 2.1 to 2.4 are loaded in the ship's transverse direction by forces due to elastic deformations of the ship's hull, are to be designed such that the sum of stresses does not exceed the permissible values given in 3.1.1.

# S21A

(cont)

## 3 Hatch cover strength criteria

### 3.1 Permissible stresses and deflections

#### 3.1.1 Stresses

The equivalent stress  $\sigma_v$  in steel hatch cover structures related to the net thickness shall not exceed  $0,8 \cdot \sigma_F$ , where  $\sigma_F$  is the minimum yield stress, in  $\text{N/mm}^2$ , of the material. For design loads according to 2.2 to 2.5, the equivalent stress  $\sigma_v$  related to the net thickness shall not exceed  $0,9 \cdot \sigma_F$  when the stresses are assessed by means of FEM.

For steels with a minimum yield stress of more than  $355 \text{ N/mm}^2$ , the value of  $\sigma_F$  to be applied throughout this requirement is subject to the individual classification society but is not to be more than the minimum yield stress of the material.

For grillage analysis, the equivalent stress may be taken as follows:

$$\sigma_v = \sqrt{\sigma^2 + 3\tau^2} \text{ in N/mm}^2$$

where:

$\sigma$  = normal stress in  $\text{N/mm}^2$

$\tau$  = shear stress in  $\text{N/mm}^2$

For FEM calculations, the equivalent stress may be taken as follows:

$$\sigma_v = \sqrt{\sigma_x^2 - \sigma_x \cdot \sigma_y + \sigma_y^2 + 3\tau^2} \text{ in N/mm}^2$$

where:

$\sigma_x$  = normal stress, in  $\text{N/mm}^2$ , in x-direction

$\sigma_y$  = normal stress, in  $\text{N/mm}^2$ , in y-direction

$\tau$  = shear stress, in  $\text{N/mm}^2$ , in the x-y plane

Indices x and y are coordinates of a two-dimensional Cartesian system in the plane of the considered structural element.

In case of FEM calculations using shell or plane strain elements, the stresses are to be read from the centre of the individual element. It is to be observed that, in particular, at flanges of unsymmetrical girders, the evaluation of stress from element centre may lead to non-conservative results. Thus, a sufficiently fine mesh is to be applied in these cases or, the stress at the element edges shall not exceed the allowable stress. Where shell elements are used, the stresses are to be evaluated at the mid plane of the element.

Stress concentrations are to be assessed to the satisfaction of the individual classification society.

## S21A (cont)

### 3.1.2 Deflection

The vertical deflection of primary supporting members due to the vertical weather design load according to 2.1 is to be not more than  $0.0056 \cdot l_g$  where  $l_g$  is the greatest span of primary supporting members.

**Note:**

Where hatch covers are arranged for carrying containers and mixed stowage is allowed, i.e., a 40'-container stowed on top of two 20'-containers, particular attention should be paid to the deflections of hatch covers. Further the possible contact of deflected hatch covers with in hold cargo has to be observed.

### 3.2 Local net plate thickness

The local net plate thickness  $t$ , in mm, of the hatch cover top plating is not to be less than:

$$t = F_p \cdot 15,8 \cdot s \sqrt{\frac{p}{0,95 \cdot \sigma_F}}$$

and to be not less than 1% of the spacing of the stiffener or 6 mm if that be greater.

$F_p$  = factor for combined membrane and bending response  
= 1,5 in general

=  $1,9 \cdot \frac{\sigma}{\sigma_a}$ , for  $\frac{\sigma}{\sigma_a} \geq 0,8$  for the attached plate flange of primary supporting members

where:

$s$  = stiffener spacing in m

$p$  = pressure  $p_H$  and  $p_L$ , in  $\text{kN/m}^2$ , as defined in 2.

$\sigma$  = maximum normal stress, in  $\text{N/mm}^2$ , of hatch cover top plating, determined according to Fig.4

$\sigma_a$  =  $0,8 \cdot \sigma_F$  in  $\text{N/mm}^2$

For flange plates under compression sufficient buckling strength according to 3.6 is to be demonstrated.

## S21A

(cont)

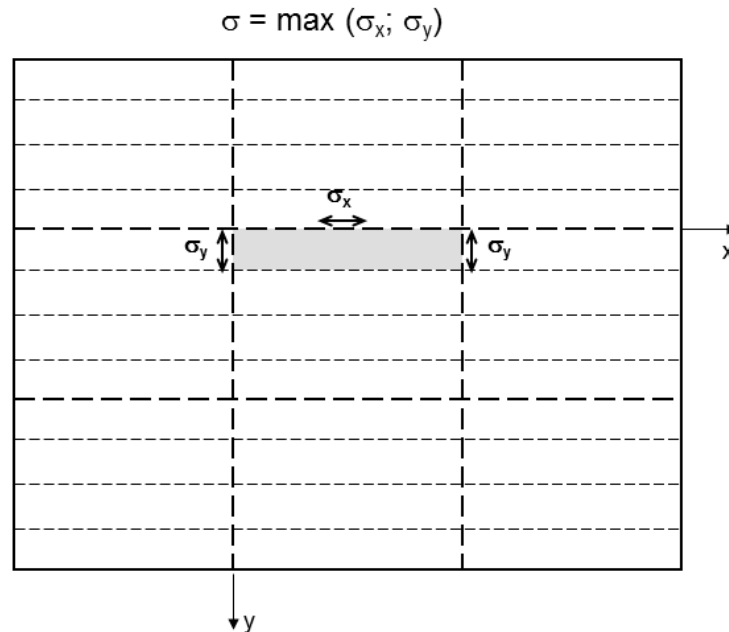

**Fig.4 Determination of normal stress of the hatch cover plating**

### 3.2.1 Local net plate thickness of hatch covers for wheel loading

The local net plate thickness of hatch covers for wheel loading have to be derived from the individual classification society's rules.

### 3.2.2 Lower plating of double skin hatch covers and box girders

The thickness to fulfill the strength requirements is to be obtained from the calculation according to 3.5 under consideration of permissible stresses according to 3.1.1. When the lower plating is taken into account as a strength member of the hatch cover, the net thickness, in mm, of lower plating is to be taken not less than 5 mm. When project cargo is intended to be carried on a hatch cover, the net thickness must not be less than:

$$t = 6,5 \cdot s \text{ in mm}$$

where:

s = stiffener spacing in m

**Note:**

*Project cargo means especially large or bulky cargo lashed to the hatch cover. Examples are parts of cranes or wind power stations, turbines, etc. Cargoes that can be considered as uniformly distributed over the hatch cover, e.g., timber, pipes or steel coils need not to be considered as project cargo.*

When the lower plating is not considered as a strength member of the hatch cover, the thickness of the lower plating should be determined according to the individual class society's rules.

## S21A (cont)

### 3.3 Net scantling of secondary stiffeners

The net section modulus  $Z$  and net shear area  $A_s$  of uniformly loaded hatch cover stiffeners constraint at both ends must not be less than:

$$Z = \frac{104 p s l^2}{\sigma_F}, \text{ in cm}^3, \text{ for design load according to 2.1}$$

$$Z = \frac{93 p s l^2}{\sigma_F}, \text{ in cm}^3, \text{ for design loads according to 2.3.1}$$

$$A_s = \frac{10.8 p s l}{\sigma_F}, \text{ in cm}^2, \text{ for design load according to 2.1}$$

$$A_s = \frac{9.6 p s l}{\sigma_F}, \text{ in cm}^2, \text{ for design loads according to 2.3.1}$$

where:

$l$  = secondary stiffener span, in m, to be taken as the spacing, in m, of primary supporting members or the distance between a primary supporting member and the edge support, as applicable.

$s$  = secondary stiffener spacing in m

$p$  = pressure  $p_H$  and  $p_L$ , in  $\text{kN/m}^2$ , as defined in 2.

For secondary stiffeners of lower plating of double skin hatch covers, requirements mentioned above are not applied due to the absence of lateral loads.

The net thickness, in mm, of the stiffener (except u-beams/trapeze stiffeners) web is to be taken not less than 4 mm.

The net section modulus of the secondary stiffeners is to be determined based on an attached plate width assumed equal to the stiffener spacing.

For flat bar secondary stiffeners and buckling stiffeners, the ratio  $h/t_w$  is to be not greater than  $15 \cdot k^{0.5}$ , where:

$h$  = height of the stiffener

$t_w$  = net thickness of the stiffener

$k$  =  $235/\sigma_F$

Stiffeners parallel to primary supporting members and arranged within the effective breadth according to 3.5.1 must be continuous at crossing primary supporting member and may be regarded for calculating the cross sectional properties of primary supporting members. It is to be verified that the combined stress of those stiffeners induced by the bending of primary supporting members and lateral pressures does not exceed the permissible stresses according to 3.1.1. The requirements of this paragraph are not applied to stiffeners of lower plating of double skin hatch covers if the lower plating is not considered as strength member.



## S21A (cont)

For hatch cover stiffeners under compression sufficient safety against lateral and torsional buckling according 3.6.3 is to be verified.

For hatch covers subject to wheel loading or point loads stiffener scantlings are to be determined under consideration of the permissible stresses according to 3.1.1 or are to be determined according to the individual class society's rules.

### 3.4 Net scantling of primary supporting members

#### 3.4.1 Primary supporting members

Scantlings of primary supporting members are obtained from calculations according to 3.5 under consideration of permissible stresses according to 3.1.1.

For all components of primary supporting members sufficient safety against buckling must be verified according to 3.6. For biaxial compressed flange plates this is to be verified within the effective widths according to 3.6.3.2.

The net thickness, in mm, of webs of primary supporting members shall not be less than:

$$t = 6,5 \cdot s \text{ in mm}$$

$$t_{\min} = 5 \text{ mm}$$

where:

s = stiffener spacing in m

#### 3.4.2 Edge girders (Skirt plates)

Scantlings of edge girders are obtained from the calculations according to 3.5 under consideration of permissible stresses according to 3.1.1.

The net thickness, in mm, of the outer edge girders exposed to wash of sea shall not be less than the largest of the following values:

$$t = 15,8 \cdot s \cdot \sqrt{\frac{p_A}{0,95 \cdot \sigma_F}}$$

$$t = 8,5 \cdot s \text{ in mm}$$

$$t_{\min} = 5 \text{ mm}$$

where:

$p_A$  = horizontal pressure as defined in 2.2

s = stiffener spacing in m

The stiffness of edge girders is to be sufficient to maintain adequate sealing pressure between securing devices. The moment of inertia, in  $\text{cm}^4$ , of edge girders is not to be less than:

$$I = 6 \cdot q \cdot s_{SD}^4$$

## S21A (cont)

where:

$q$  = packing line pressure in N/mm, minimum 5 N/mm

$s_{SD}$  = spacing, in m, of securing devices

### 3.5 Strength calculations

Strength calculation for hatch covers may be carried out by either grillage analysis or FEM. Double skin hatch covers or hatch covers with box girders are to be assessed using FEM, refer to 3.5.2.

#### 3.5.1 Effective cross-sectional properties for calculation by grillage analysis

Cross-sectional properties are to be determined considering the effective breadth. Cross sectional areas of secondary stiffeners parallel to the primary supporting member under consideration within the effective breadth can be included, refer Fig.6.

The effective breadth of plating  $e_m$  of primary supporting members is to be determined according to Tab.4, considering the type of loading. Special calculations may be required for determining the effective breadth of one-sided or non-symmetrical flanges.

The effective cross sectional area of plates is not to be less than the cross sectional area of the face plate.

For flange plates under compression with secondary stiffeners perpendicular to the web of the primary supporting member, the effective width is to be determined according to 3.6.3.2.

**Tab. 4 Effective breadth  $e_m$  of plating of primary supporting members**

l/e	0	1	2	3	4	5	6	7	$\geq 8$
$e_{m1}/e$	0	0.36	0.64	0.82	0.91	0.96	0.98	1.00	1.00
$e_{m2}/e$	0	0.20	0.37	0.52	0.65	0.75	0.84	0.89	0.90

$e_{m1}$  is to be applied where primary supporting members are loaded by uniformly distributed loads or else by not less than 6 equally spaced single loads

$e_{m2}$  is to be applied where primary supporting members are loaded by 3 or less single loads

Intermediate values may be obtained by direct interpolation.

l length of zero-points of bending moment curve:  
 $l = l_0$  for simply supported primary supporting members  
 $l = 0,6 \cdot l_0$  for primary supporting members with both ends constraint,  
 where  $l_0$  is the unsupported length of the primary supporting member

e width of plating supported, measured from centre to centre of the adjacent unsupported fields

#### 3.5.2 General requirements for FEM calculations

For strength calculations of hatch covers by means of finite elements, the cover geometry shall be idealized as realistically as possible. Element size must be appropriate to account for

## S21A (cont)

effective breadth. In no case element width shall be larger than stiffener spacing. In way of force transfer points and cutouts the mesh has to be refined where applicable. The ratio of element length to width shall not exceed 4.

The element height of webs of primary supporting member must not exceed one-third of the web height. Stiffeners, supporting plates against pressure loads, have to be included in the idealization. Stiffeners may be modelled by using shell elements, plane stress elements or beam elements. Buckling stiffeners may be disregarded for the stress calculation.

### 3.6 Buckling strength of hatch cover structures

For hatch cover structures sufficient buckling strength is to be demonstrated.

The buckling strength assessment of coaming parts is to be done according to the individual class society's rules.

#### Definitions

- a = length of the longer side of a single plate field in mm (x-direction)
- b = breadth of the shorter side of a single plate field in mm (y-direction)
- $\alpha$  = aspect ratio of single plate field  
= a / b
- n = number of single plate field breadths within the partial or total plate field
- t = net plate thickness in mm
- $\sigma_x$  = membrane stress, in N/mm<sup>2</sup>, in x-direction
- $\sigma_y$  = membrane stress, in N/mm<sup>2</sup>, in y-direction
- $\tau$  = shear stress, in N/mm<sup>2</sup>, in the x-y plane
- E = modulus of elasticity, in N/mm<sup>2</sup>, of the material  
= 2,06 · 10<sup>5</sup> N/mm<sup>2</sup> for steel
- $\sigma_F$  = minimum yield stress, in N/mm<sup>2</sup>, of the material

Compressive and shear stresses are to be taken positive, tension stresses are to be taken negative.

# S21A

(cont)

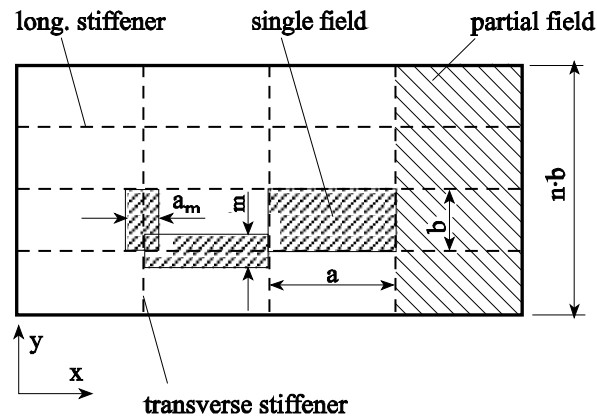

longitudinal : stiffener in the direction of the length  $a$   
 transverse : stiffener in the direction of the breath  $b$

**Fig. 5 General arrangement of panel**

**Note:**

If stresses in the  $x$ - and  $y$ -direction already contain the Poisson-effect (calculated using FEM), the following modified stress values may be used. Both stresses  $\sigma_x^*$  and  $\sigma_y^*$  are to be compressive stresses, in order to apply the stress reduction according to the following formulae:

$$\sigma_x = (\sigma_x^* - 0,3 \cdot \sigma_y^*) / 0,91$$

$$\sigma_y = (\sigma_y^* - 0,3 \cdot \sigma_x^*) / 0,91$$

$\sigma_x^*$ ,  $\sigma_y^*$  = stresses containing the Poisson-effect

Where compressive stress fulfils the condition  $\sigma_y^* < 0,3 \sigma_x^*$ , then  $\sigma_y = 0$  and  $\sigma_x = \sigma_x^*$

Where compressive stress fulfils the condition  $\sigma_x^* < 0,3 \sigma_y^*$ , then  $\sigma_x = 0$  and  $\sigma_y = \sigma_y^*$

$F_1$  = correction factor for boundary condition at the longitudinal stiffeners according to Tab.5.

# S21A

(cont)

**Tab. 5 Correction factor  $F_1$**

Stiffeners sniped at both ends	1,00
Guidance values <sup>1</sup> where both ends are effectively connected to adjacent structures	1,05 for flat bars 1,10 for bulb sections 1,20 for angle and tee-sections 1,30 for u-type sections <sup>2</sup> and girders of high rigidity
An average value of $F_1$ is to be used for plate panels having different edge stiffeners	
<sup>1</sup> Exact values may be determined by direct calculations <sup>2</sup> Higher value may be taken if it is verified by a buckling strength check of the partial plate field using non-linear FEA and deemed appropriate by the individual class society but not greater than 2.0	

$\sigma_e$  = reference stress, in N/mm<sup>2</sup>, taken equal to

$$= 0,9 \cdot E \left( \frac{t}{b} \right)^2$$

$\Psi$  = edge stress ratio taken equal to

$$= \sigma_2 / \sigma_1 \text{ where}$$

$\sigma_1$  = maximum compressive stress

$\sigma_2$  = minimum compressive stress or tension stress

S = safety factor (based on net scantling approach), taken equal to

= 1.25 for hatch covers when subjected to the vertical weather design load according to 2.1

= 1.10 for hatch covers when subjected to loads according to 2.3 to 2.5

$\lambda$  = reference degree of slenderness, taken equal to:

$$= \sqrt{\frac{\sigma_F}{K \cdot \sigma_e}}$$

K = buckling factor according to Tab.7.

### 3.6.1 Proof of top and lower hatch cover plating

Proof is to be provided that the following condition is complied with for the single plate field a · b:

$$\left( \frac{|\sigma_x| \cdot S}{\kappa_x \cdot \sigma_F} \right)^{e1} + \left( \frac{|\sigma_y| \cdot S}{\kappa_y \cdot \sigma_F} \right)^{e2} - B \left( \frac{\sigma_x \cdot \sigma_y \cdot S^2}{\sigma_F^2} \right) + \left( \frac{|\tau| \cdot S \cdot \sqrt{3}}{\kappa_\tau \cdot \sigma_F} \right)^{e3} \leq 1,0$$

The first two terms and the last term of the above condition shall not exceed 1,0.

## S21A

(cont)

The reduction factors  $\kappa_x$ ,  $\kappa_y$  and  $\kappa_\tau$  are given in Tab.7.

Where  $\sigma_x \leq 0$  (tension stress),  $\kappa_x = 1,0$ .

Where  $\sigma_y \leq 0$  (tension stress),  $\kappa_y = 1,0$ .

The exponents  $e_1$ ,  $e_2$  and  $e_3$  as well as the factor  $B$  are to be taken as given by Tab. 6.

**Tab. 6 Coefficients  $e_1$ ,  $e_2$ ,  $e_3$  and factor  $B$**

Exponents $e_1$ - $e_3$ and factor $B$	Plate panel
$e_1$	$1 + \kappa_x^4$
$e_2$	$1 + \kappa_y^4$
$e_3$	$1 + \kappa_x \cdot \kappa_y \cdot \kappa_\tau^2$
$B$ $\sigma_x$ and $\sigma_y$ positive (compression stress)	$(\kappa_x \cdot \kappa_y)^5$
$B$ $\sigma_x$ or $\sigma_y$ negative (tension stress)	1

**S21A**  
(cont)

**Tab. 7 Buckling and reduction factors for plane elementary plate panels**

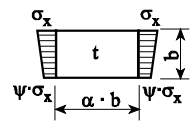
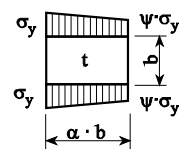
Buckling-Load Case	Edge stress ratio $\psi$	Asp. ratio $\alpha = a/b$	Buckling factor K	Reduction factor $\kappa$
<b>1</b> 	$1 \geq \psi \geq 0$	$\alpha \geq 1$	$K = \frac{8,4}{\psi + 1,1}$	$\kappa_x = 1$ for $\lambda \leq \lambda_c$ $\kappa_x = c \left( \frac{1}{\lambda} - \frac{0,22}{\lambda^2} \right)$ for $\lambda > \lambda_c$ $c = (1,25 - 0,12\psi) \leq 1,25$ $\lambda_c = \frac{c}{2} \left( 1 + \sqrt{1 - \frac{0,88}{c}} \right)$
	$0 > \psi > -1$		$K = 7,63 - \psi(6,26 - 10\psi)$	
	$\psi \leq -1$		$K = (1 - \psi)^2 \cdot 5,975$	
<b>2</b> 	$1 \geq \psi \geq 0$	$\alpha \geq 1$	$K = F_1 \left( 1 + \frac{1}{\alpha^2} \right)^2 \cdot \frac{2,1}{(\psi + 1,1)}$	$\kappa_y = c \left( \frac{1}{\lambda} - \frac{R + F^2(H - R)}{\lambda^2} \right)$ $c = (1,25 - 0,12\psi) \leq 1,25$ $R = \lambda \left( 1 - \frac{\lambda}{c} \right)$ for $\lambda < \lambda_c$ $R = 0,22$ for $\lambda \geq \lambda_c$ $\lambda_c = \frac{c}{2} \left( 1 + \sqrt{1 - \frac{0,88}{c}} \right)$
	$0 > \psi > -1$	$1 \leq \alpha \leq 1,5$	$K = F_1 \left[ \left( 1 + \frac{1}{\alpha^2} \right)^2 \cdot \frac{2,1(1 + \psi)}{1,1} - \frac{\psi}{\alpha^2} (13,9 - 10\psi) \right]$	$R = \lambda \left( 1 - \frac{\lambda}{c} \right)$ for $\lambda < \lambda_c$ $R = 0,22$ for $\lambda \geq \lambda_c$ $\lambda_c = \frac{c}{2} \left( 1 + \sqrt{1 - \frac{0,88}{c}} \right)$
		$\alpha > 1,5$	$K = F_1 \left[ \left( 1 + \frac{1}{\alpha^2} \right)^2 \cdot \frac{2,1(1 + \psi)}{1,1} - \frac{\psi}{\alpha^2} \cdot (5,87 + 1,87\alpha^2 + \frac{8,6}{\alpha^2} - 10\psi) \right]$	$F = \left( 1 - \frac{\frac{K}{\lambda_p^2} - 1}{\lambda_p^2} \right) \cdot c_1 \geq 0$ $\lambda_p^2 = \lambda^2 - 0,5$ for $1 \leq \lambda_p^2 \leq 3$ $c_1 = \left( 1 - \frac{F_1}{\alpha} \right) \geq 0$ $H = \lambda - \frac{2\lambda}{c(T + \sqrt{T^2 - 4})} \geq R$ $T = \lambda + \frac{14}{15\lambda} + \frac{1}{3}$
	$\psi \leq -1$	$1 \leq \alpha \leq \frac{3(1 - \psi)}{4}$	$K = F_1 \left( \frac{1 - \psi}{\alpha} \right)^2 \cdot 5,975$	
		$\alpha > \frac{3(1 - \psi)}{4}$	$K = F_1 \left[ \left( \frac{1 - \psi}{\alpha} \right)^2 \cdot 3,9675 + 0,5375 \left( \frac{1 - \psi}{\alpha} \right)^4 + 1,87 \right]$	
	Explanations for boundary conditions			- - - - - plate edge free ————— plate edge simply supported

## S21A (cont)

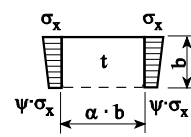
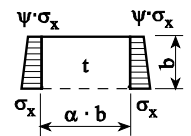
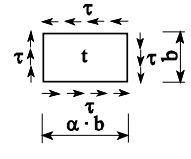
	$1 \geq \psi \geq 0$	$\alpha > 0$	$K = \frac{4 \left( 0,425 + \frac{1}{\alpha^2} \right)}{3\psi + 1}$	$\kappa_x = 1$ for $\lambda \leq 0,7$ $\kappa_x = \frac{1}{\lambda^2 + 0,51}$ for $\lambda > 0,7$
	$0 > \psi \geq -1$		$K = 4 \left( 0,425 + \frac{1}{\alpha^2} \right) (1 + \psi) - 5\psi(1 - 3,42\psi)$	
	$1 \geq \psi \geq -1$	$\alpha > 0$	$K = \left( 0,425 + \frac{1}{\alpha^2} \right) \frac{3 - \psi}{2}$	
	====		$K = K_\tau \cdot \sqrt{3}$	$\kappa_\tau = 1$ for $\lambda \leq 0,84$ $\kappa_\tau = \frac{0,84}{\lambda}$ for $\lambda > 0,84$
		$\alpha \geq 1$	$K_\tau = \left[ 5,34 + \frac{4}{\alpha^2} \right]$	
		$0 < \alpha < 1$	$K_\tau = \left[ 4 + \frac{5,34}{\alpha^2} \right]$	
Explanations for boundary conditions		- - - - - plate edge free ————— plate edge simply supported		

### 3.6.2 Webs and flanges of primary supporting members

For non-stiffened webs and flanges of primary supporting members sufficient buckling strength as for the hatch cover top and lower plating is to be demonstrated according to 3.6.1.

### 3.6.3 Proof of partial and total fields of hatch covers

#### 3.6.3.1 Longitudinal and transverse secondary stiffeners

It is to be demonstrated that the continuous longitudinal and transverse stiffeners of partial and total plate fields comply with the conditions set out in 3.6.3.3 through 3.6.3.4.

For u-type stiffeners, the proof of torsional buckling strength according to 3.6.3.4 can be omitted.

Single-side welding is not permitted to use for secondary stiffeners except for u-stiffeners.

#### 3.6.3.2 Effective width of top and lower hatch cover plating

For demonstration of buckling strength according to 3.6.3.3 through 3.6.3.4 the effective width of plating may be determined by the following formulae:

$$b_m = \kappa_x \cdot b \quad \text{for longitudinal stiffeners}$$

$$a_m = \kappa_y \cdot a \quad \text{for transverse stiffeners}$$

see also Fig.5.

The effective width of plating is not to be taken greater than the value obtained from 3.5.1.

The effective width  $e'_m$  of stiffened flange plates of primary supporting members may be determined as follows:



# S21A

(cont)

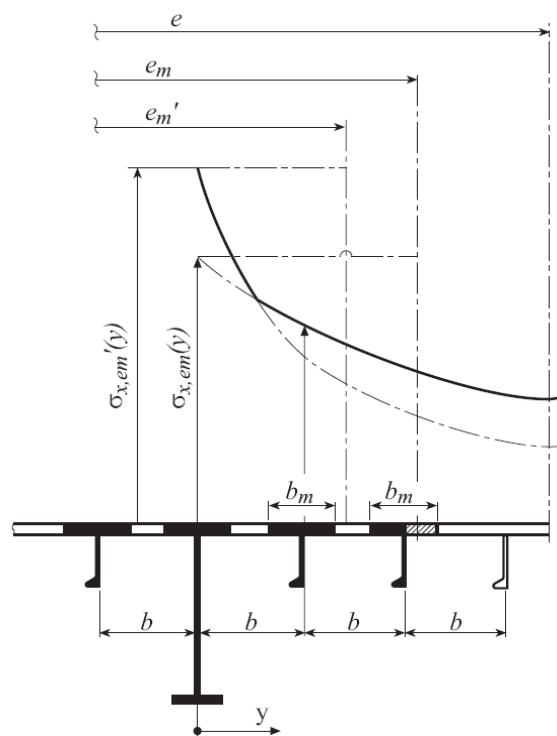

**Fig. 6 Stiffening parallel to web of primary supporting member**

$$b < e_m$$

$$e'_m = n \cdot b_m$$

$n$  = integer number of stiffener spacings  $b$  inside the effective breadth  $e_m$  according to 3.5.1

$$= \text{int} \left( \frac{e_m}{b} \right)$$

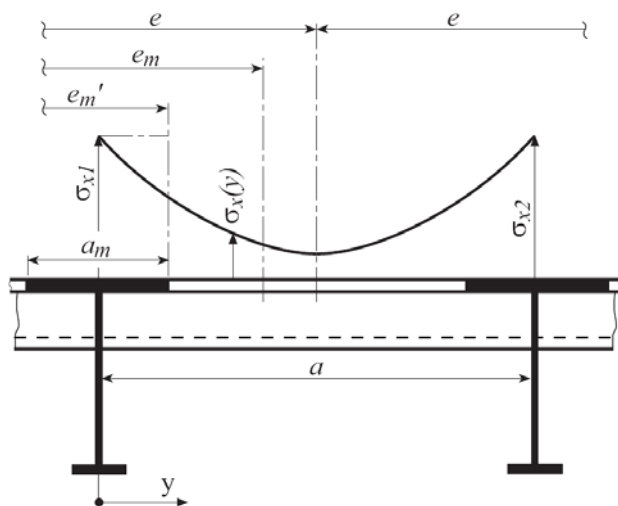

**Fig. 7 Stiffening perpendicular to web of primary supporting member**

$$a \geq e_m$$

$$e'_m = n \cdot a_m < e_m$$

$$n = 2,7 \cdot \frac{e_m}{a} \leq 1$$

$e$  = width of plating supported according to 3.5.1

## S21A (cont)

For  $b \geq e_m$  or  $a < e_m$ , respectively,  $b$  and  $a$  have to be exchanged.

$a_m$  and  $b_m$  for flange plates are in general to be determined for  $\psi = 1$ .

### Note:

Scantlings of plates and stiffeners are in general to be determined according to the maximum stresses  $\sigma_x(y)$  at webs of primary supporting member and stiffeners, respectively. For stiffeners with spacing  $b$  under compression arranged parallel to primary supporting members no value less than  $0,25 \cdot \sigma_F$  shall be inserted for  $\sigma_x(y=b)$ .

The stress distribution between two primary supporting members can be obtained by the following formula:

$$\sigma_x(y) = \sigma_{x1} \cdot \left\{ 1 - \frac{y}{e} \left[ 3 + c_1 - 4 \cdot c_2 - 2 \frac{y}{e} (1 + c_1 - 2 c_2) \right] \right\}$$

where:

$$c_1 = \frac{\sigma_{x2}}{\sigma_{x1}} \quad 0 \leq c_1 \leq 1$$

$$c_2 = \frac{1,5}{e} \cdot (e''_{m1} + e''_{m2}) - 0,5$$

$e''_{m1}$  = proportionate effective breadth  $e_{m1}$  or proportionate effective width  $e'_{m1}$  of primary supporting member 1 within the distance  $e$ , as appropriate

$e''_{m2}$  = proportionate effective breadth  $e_{m2}$  or proportionate effective width  $e'_{m2}$  of primary supporting member 2 within the distance  $e$ , as appropriate

$\sigma_{x1}, \sigma_{x2}$  = normal stresses in flange plates of adjacent primary supporting member 1 and 2 with spacing  $e$ , based on cross-sectional properties considering the effective breadth or effective width, as appropriate

$y$  = distance of considered location from primary supporting member 1

Shear stress distribution in the flange plates may be assumed linearly.

### 3.6.3.3 Lateral buckling of secondary stiffeners

$$\frac{\sigma_a + \sigma_b}{\sigma_F} S \leq 1$$

where:

$\sigma_a$  = uniformly distributed compressive stress, in  $\text{N/mm}^2$  in the direction of the stiffener axis.

$\sigma_a$  =  $\sigma_x$  for longitudinal stiffeners

$\sigma_a$  =  $\sigma_y$  for transverse stiffeners

$\sigma_b$  = bending stress, in  $\text{N/mm}^2$ , in the stiffener

# S21A

(cont)

$$= \frac{M_0 + M_1}{Z_{st} \cdot 10^3}$$

$M_0$  = bending moment, in Nmm, due to the deformation  $w$  of stiffener, taken equal to:

$$M_0 = F_{Ki} \frac{p_z \cdot w}{c_f - p_z} \quad \text{with } (c_f - p_z) > 0$$

$M_1$  = bending moment, in Nmm, due to the lateral load  $p$  equal to:

$$M_1 = \frac{p \cdot b \cdot a^2}{24 \cdot 10^3} \quad \text{for longitudinal stiffeners}$$

$$M_1 = \frac{p \cdot a(n \cdot b)^2}{c_s \cdot 8 \cdot 10^3} \quad \text{for transverse stiffeners}$$

$n$  is to be taken equal to 1 for ordinary transverse stiffeners.

$p$  = lateral load in kN/m<sup>2</sup>

$F_{Ki}$  = ideal buckling force, in N, of the stiffener

$$F_{Kix} = \frac{\pi^2}{a^2} \cdot E \cdot I_x \cdot 10^4 \quad \text{for longitudinal stiffeners}$$

$$F_{Kiy} = \frac{\pi^2}{(n \cdot b)^2} \cdot E \cdot I_y \cdot 10^4 \quad \text{for transverse stiffeners}$$

$I_x, I_y$  = net moments of inertia, in cm<sup>4</sup>, of the longitudinal or transverse stiffener including effective width of attached plating according to 3.6.3.2.  $I_x$  and  $I_y$  are to comply with the following criteria:

$$I_x \geq \frac{b \cdot t^3}{12 \cdot 10^4}$$

$$I_y \geq \frac{a \cdot t^3}{12 \cdot 10^4}$$

$p_z$  = nominal lateral load, in N/mm<sup>2</sup>, of the stiffener due to  $\sigma_x$ ,  $\sigma_y$  and  $\tau$

$$p_{zx} = \frac{t}{b} \left( \sigma_{xl} \left( \frac{\pi \cdot b}{a} \right)^2 + 2 \cdot c_y \cdot \sigma_y + \sqrt{2} \tau_1 \right) \quad \text{for longitudinal stiffeners}$$

$$p_{zy} = \frac{t}{a} \left( 2 \cdot c_x \cdot \sigma_{xl} + \sigma_y \left( \frac{\pi \cdot a}{n \cdot b} \right)^2 \left( 1 + \frac{A_y}{a \cdot t} \right) + \sqrt{2} \tau_1 \right) \quad \text{for transverse stiffeners}$$

$$\sigma_{xl} = \sigma_x \left( 1 + \frac{A_x}{b \cdot t} \right)$$

$c_x, c_y$  = factor taking into account the stresses perpendicular to the stiffener's axis and distributed variable along the stiffener's length

$$= 0,5 \cdot (1 + \Psi) \quad \text{for } 0 \leq \Psi \leq 1$$

## S21A

(cont)

$$= \frac{0,5}{1 - \Psi} \quad \text{for } \Psi < 0$$

$A_x, A_y$  = net sectional area, in mm<sup>2</sup>, of the longitudinal or transverse stiffener, respectively, without attached plating

$$\tau_1 = \left[ \tau - t \sqrt{\sigma_F \cdot E \left( \frac{m_1}{a^2} + \frac{m_2}{b^2} \right)} \right] \geq 0$$

for longitudinal stiffeners:

$$\frac{a}{b} \geq 2,0 \quad : \quad m_1 = 1,47 \quad m_2 = 0,49$$

$$\frac{a}{b} < 2,0 \quad : \quad m_1 = 1,96 \quad m_2 = 0,37$$

for transverse stiffeners:

$$\frac{a}{n \cdot b} \geq 0,5 \quad : \quad m_1 = 0,37 \quad m_2 = \frac{1,96}{n^2}$$

$$\frac{a}{n \cdot b} < 0,5 \quad : \quad m_1 = 0,49 \quad m_2 = \frac{1,47}{n^2}$$

$$w = w_0 + w_1$$

$w_0$  = assumed imperfection in mm

$$w_{0,x} \leq \min\left(\frac{a}{250}, \frac{b}{250}, 10\right) \text{ for longitudinal stiffeners}$$

$$w_{0,y} \leq \min\left(\frac{a}{250}, \frac{n \cdot b}{250}, 10\right) \text{ for transverse stiffeners}$$

### Note:

For stiffeners sniped at both ends  $w_0$  must not be taken less than the distance from the midpoint of plating to the neutral axis of the profile including effective width of plating.

$w_1$  = Deformation of stiffener, in mm, at midpoint of stiffener span due to lateral load  $p$ .

In case of uniformly distributed load the following values for  $w_1$  may be used:

$$w_1 = \frac{p \cdot b \cdot a^4}{384 \cdot 10^7 \cdot E \cdot I_x} \text{ for longitudinal stiffeners}$$

$$w_1 = \frac{5 \cdot a \cdot p \cdot (n \cdot b)^4}{384 \cdot 10^7 \cdot E \cdot I_y \cdot c_s^2} \text{ for transverse stiffeners}$$

$c_f$  = elastic support provided by the stiffener, in N/mm<sup>2</sup>

i. For longitudinal stiffeners:

$$c_{fx} = F_{Kix} \cdot \frac{\pi^2}{a^2} \cdot (1 + c_{px})$$

## S21A

(cont)

$$c_{px} = \frac{1}{1 + \frac{0,91 \cdot \left( \frac{12 \cdot 10^4 \cdot I_x}{t^3 \cdot b} - 1 \right)}{c_{xa}}}$$

$$c_{xa} = \left[ \frac{a}{2b} + \frac{2b}{a} \right]^2 \quad \text{for } a \geq 2b$$

$$c_{xa} = \left[ 1 + \left( \frac{a}{2b} \right)^2 \right]^2 \quad \text{for } a < 2b$$

ii. For transverse stiffeners:

$$c_{fy} = c_s \cdot F_{Kiy} \cdot \frac{\pi^2}{(n \cdot b)^2} \cdot (1 + c_{py})$$

$$c_{py} = \frac{1}{1 + \frac{0,91 \cdot \left( \frac{12 \cdot 10^4 \cdot I_y}{t^3 \cdot a} - 1 \right)}{c_{ya}}}$$

$$c_{ya} = \left[ \frac{n \cdot b}{2a} + \frac{2a}{n \cdot b} \right]^2 \quad \text{for } n \cdot b \geq 2a$$

$$c_{ya} = \left[ 1 + \left( \frac{n \cdot b}{2a} \right)^2 \right]^2 \quad \text{for } n \cdot b < 2a$$

$c_s$  = factor accounting for the boundary conditions of the transverse stiffener  
 = 1,0 for simply supported stiffeners  
 = 2,0 for partially constraint stiffeners

$Z_{st}$  = net section modulus of stiffener (long. or transverse) in  $\text{cm}^3$  including effective width of plating according to 3.6.3.2.

If no lateral load  $p$  is acting the bending stress  $\sigma_b$  is to be calculated at the midpoint of the stiffener span for that fibre which results in the largest stress value. If a lateral load  $p$  is acting, the stress calculation is to be carried out for both fibres of the stiffener's cross sectional area (if necessary for the biaxial stress field at the plating side).

### 3.6.3.4 Torsional buckling of secondary stiffeners

#### 3.6.3.4.1 Longitudinal secondary stiffeners

The longitudinal ordinary stiffeners are to comply with the following criteria:

$$\frac{\sigma_x \cdot S}{\kappa_T \cdot \sigma_F} \leq 1,0$$

$\kappa_T$  = coefficient taken equal to:

# S21A

(cont)

$$\kappa_T = 1,0 \text{ for } \lambda_T \leq 0,2$$

$$\kappa_T = \frac{1}{\Phi + \sqrt{\Phi^2 - \lambda_T^2}} \text{ for } \lambda_T > 0,2$$

$$\Phi = 0,5(1 + 0,21(\lambda_T - 0,2) + \lambda_T^2)$$

$\lambda_T$  = reference degree of slenderness taken equal to:

$$\lambda_T = \sqrt{\frac{\sigma_F}{\sigma_{KIT}}}$$

$$\sigma_{KIT} = \frac{E}{I_p} \left( \frac{\pi^2 \cdot I_\omega \cdot 10^2}{a^2} \varepsilon + 0,385 \cdot I_T \right), \text{ in N/mm}^2$$

For  $I_p$ ,  $I_T$ ,  $I_\omega$  see Fig.8 and Tab.8.

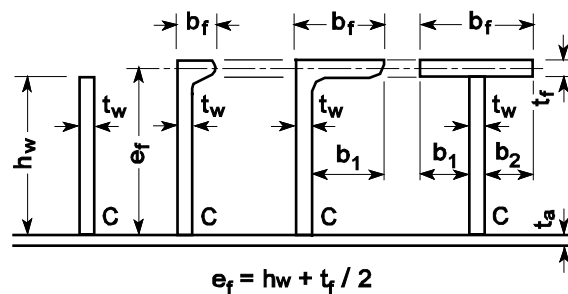

**Fig. 8 Dimensions of stiffener**

$I_p$  = net polar moment of inertia of the stiffener, in  $\text{cm}^4$ , related to the point C

$I_T$  = net St. Venant's moment of inertia of the stiffener, in  $\text{cm}^4$

$I_\omega$  = net sectorial moment of inertia of the stiffener, in  $\text{cm}^6$ , related to the point C

$\varepsilon$  = degree of fixation taken equal to:

$$\varepsilon = 1 + 10^{-3} \sqrt{\frac{a^4}{\frac{3}{4} \pi^4 \cdot I_\omega \left( \frac{b}{t^3} + \frac{4h_w}{3t_w^3} \right)}}$$

$h_w$  = web height, in mm

$t_w$  = net web thickness, in mm

$b_f$  = flange breadth, in mm

$t_f$  = net flange thickness, in mm

$A_w$  = net web area equal to:  $A_w = h_w \cdot t_w$

$A_f$  = net flange area equal to:  $A_f = b_f \cdot t_f$

$$e_f = h_w + \frac{t_f}{2}, \text{ in mm}$$

# S21A

(cont)

**Tab. 8 Moments of inertia**

Section	$I_P$	$I_T$	$I_\omega$
Flat bar	$\frac{h_w^3 \cdot t_w}{3 \cdot 10^4}$	$\frac{h_w \cdot t_w^3}{3 \cdot 10^4} \left(1 - 0,63 \frac{t_w}{h_w}\right)$	$\frac{h_w^3 \cdot t_w^3}{36 \cdot 10^6}$
Sections with bulb or flange	$\left(\frac{A_w \cdot h_w^2}{3} + A_f \cdot e_f^2\right) 10^{-4}$	$\frac{h_w \cdot t_w^3}{3 \cdot 10^4} \left(1 - 0,63 \frac{t_w}{h_w}\right) + \frac{b_f \cdot t_f^3}{3 \cdot 10^4} \left(1 - 0,63 \frac{t_f}{b_f}\right)$	for bulb and angle sections: $\frac{A_f \cdot e_f^2 \cdot b_f^2}{12 \cdot 10^6} \left(\frac{A_f + 2,6A_w}{A_f + A_w}\right)$ for tee-sections: $\frac{b_f^3 \cdot t_f \cdot e_f^2}{12 \cdot 10^6}$

### 3.6.3.4.2 Transverse secondary stiffeners

For transverse secondary stiffeners loaded by compressive stresses and which are not supported by longitudinal stiffeners, sufficient torsional buckling strength is to be demonstrated analogously in accordance with 3.6.3.4.1.

## 4 Details of hatch covers

### 4.1 Container foundations on hatch covers

Container foundations are to be designed to the satisfaction of the individual class society. The substructures of container foundations are to be designed for cargo and container loads according to 2, applying the permissible stresses according to 3.1.1.

### 4.2 Weather tightness

Further to the following requirements IACS Rec. 14 is applicable to hatch covers.

#### 4.2.1 Packing material (General)

The packing material is to be suitable for all expected service conditions of the ship and is to be compatible with the cargoes to be transported. The packing material is to be selected with regard to dimensions and elasticity in such a way that expected deformations can be carried. Forces are to be carried by the steel structure only.

The packings are to be compressed so as to give the necessary tightness effect for all expected operating conditions. Special consideration shall be given to the packing arrangement in ships with large relative movements between hatch covers and coamings or between hatch cover sections.

## S21A (cont)

### 4.2.2 Dispensation of weather tight gaskets

For hatch covers of cargo holds solely for the transport of containers, upon request by the owners and subject to compliance with the following conditions the fitting of weather tight gaskets according to 4.2.1 may be dispensed with:

- The hatchway coamings shall be not less than 600 mm in height.
- The exposed deck on which the hatch covers are located is situated above a depth  $H(x)$ .  $H(x)$  is to be shown to comply with the following criteria:

$$H(x) \geq T_{fb} + f_b + h \text{ in m}$$

$T_{fb}$  = draught, in m, corresponding to the assigned summer load line

$f_b$  = minimum required freeboard, in m, determined in accordance with ICLL Reg. 28 as modified by further regulations as applicable

$$h = 4,6 \text{ m for } \frac{x}{L_{LL}} \leq 0,75$$

$$= 6,9 \text{ m for } \frac{x}{L_{LL}} > 0,75$$

- Labyrinths, gutter bars or equivalent are to be fitted proximate to the edges of each panel in way of the coamings. The clear profile of these openings is to be kept as small as possible.
- Where a hatch is covered by several hatch cover panels the clear opening of the gap in between the panels shall be not wider than 50mm.
- The labyrinths and gaps between hatch cover panels shall be considered as unprotected openings with respect to the requirements of intact and damage stability calculations.
- With regard to drainage of cargo holds and the necessary fire-fighting system reference is made to the sections *Piping Systems, Valves and Pumps* and *Fire Protection and Fire Extinguishing Equipment* of the individual classification society's rules.
- Bilge alarms should be provided in each hold fitted with non-weather-tight covers.
- Furthermore, Chapter 3 of IMO MSC/Circ. 1087 is to be referred to concerning the stowage and segregation of containers containing dangerous goods.

### 4.2.3 Drainage arrangements

Cross-joints of multi-panel covers are to be provided with efficient drainage arrangements.

## 5 Hatch coaming strength criteria

### 5.1 Local net plate thickness of coamings

The net thickness of weather deck hatch coamings shall not be less than the larger of the following values:



## S21A (cont)

$$t = 14,2 \cdot s \cdot \sqrt{\frac{p_A}{0,95 \cdot \sigma_F}} \text{ in mm}$$

$$t_{min} = 6 + \frac{L_1}{100} \text{ in mm}$$

where:

s = stiffener spacing in m

L<sub>1</sub> = L, need not be taken greater than 300 m

Longitudinal strength aspects are to be observed.

### 5.2 Net scantling of secondary stiffeners of coamings

The stiffeners must be continuous at the coaming stays. For stiffeners with both ends constraint the elastic net section modulus Z in cm<sup>3</sup> and net shear area A<sub>s</sub> in cm<sup>2</sup>, calculated on the basis of net thickness, must not be less than:

$$Z = \frac{83}{\sigma_F} \cdot s \cdot l^2 \cdot p_A$$

$$A_s = \frac{10 \cdot s \cdot l \cdot p_A}{\sigma_F}$$

where:

l = secondary stiffener span, in m, to be taken as the spacing of coaming stays

s = stiffener spacing in m

For sniped stiffeners of coaming at hatch corners section modulus and shear area at the fixed support have to be increased by 35 %. The gross thickness of the coaming plate at the sniped stiffener end shall not be less than:

$$t = 19,6 \cdot \sqrt{\frac{p_A \cdot s \cdot (l - 0,5 s)}{\sigma_F}} \text{ in mm}$$

Horizontal stiffeners on hatch coamings, which are part of the longitudinal hull structure, are to be designed according to the individual classification society's rules.

### 5.3 Coaming stays

Coaming stays are to be designed for the loads transmitted through them and permissible stresses according to 3.1.1.

#### 5.3.1 Coaming stay section modulus and web thickness

At the connection with deck, the net section modulus Z, in cm<sup>3</sup>, and the gross thickness t<sub>w</sub>, in mm, of the coaming stays designed as beams with flange (examples 1 and 2 are shown in Fig. 9) are to be taken not less than:

$$Z = \frac{526}{\sigma_F} \cdot e \cdot h_s^2 \cdot p_A \text{ in cm}^3$$

## S21A (cont)

$$t_w = \frac{2}{\sigma_F} \cdot \frac{e \cdot h_s \cdot p_A}{h_w} + t_s \quad \text{in mm}$$

where:

$e$  = spacing of coaming stays in m

$h_s$  = height of coaming stays in m

$h_w$  = web height of coaming stay at its lower end in m

$t_s$  = corrosion addition, in mm, according to 7

For other designs of coaming stays, such as those shown in Fig. 9, examples 3 and 4, the stresses are to be determined through a grillage analysis or FEM. The calculated stresses are to comply with the permissible stresses according to 3.1.1.

Coaming stays are to be supported by appropriate substructures. Face plates may only be included in the calculation if an appropriate substructure is provided and welding provides an adequate joint.

Webs are to be connected to the deck by fillet welds on both sides with a throat thickness of  $a = 0,44t_w$ . The size of welding for toes of webs at the lower end of coaming stays should be according to the individual class society's rules.

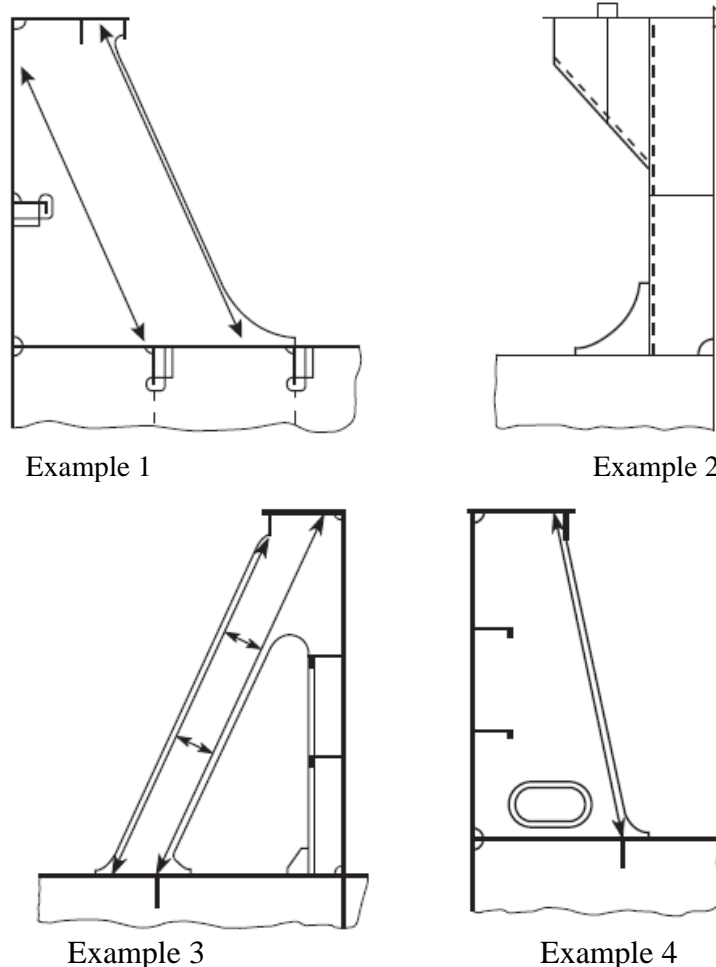

**Fig. 9** Examples of coaming stays

**S21A**  
(cont)**5.3.2 Coaming stays under friction load**

For coaming stays, which transfer friction forces at hatch cover supports, fatigue strength is to be considered according to individual class society's rules, refer to 6.2.2.

**5.4 Further requirements for hatch coamings****5.4.1 Longitudinal strength**

Hatch coamings which are part of the longitudinal hull structure are to be designed according to the requirements for longitudinal strength of the individual classification society.

For structural members welded to coamings and for cutouts in the top of coamings sufficient fatigue strength is to be verified.

Longitudinal hatch coamings with a length exceeding  $0,1 \cdot L$  m are to be provided with tapered brackets or equivalent transitions and a corresponding substructure at both ends. At the end of the brackets they are to be connected to the deck by full penetration welds of minimum 300 mm in length.

**5.4.2 Local details**

If the design of local details is not regulated in 5, local details are to comply with the individual classification society's requirement for the purpose of transferring the loads on the hatch covers to the hatch coamings and, through them, to the deck structures below. Hatch coamings and supporting structures are to be adequately stiffened to accommodate the loading from hatch covers, in longitudinal, transverse and vertical directions.

Structures under deck are to be checked against the load transmitted by the stays.

Unless otherwise stated, weld connections and materials are to be dimensioned and selected in accordance with the individual classification society's requirements.

**5.4.3 Stays**

On ships carrying cargo on deck, such as timber, coal or coke, the stays are to be spaced not more than 1,5 m apart.

**5.4.4 Extend of coaming plates**

Coaming plates are to extend to the lower edge of the deck beams or hatch side girders are to be fitted that extend to the lower edge of the deck beams. Extended coaming plates and hatch side girders are to be flanged or fitted with face bars or half-round bars. Fig.10 gives an example.

## S21A (cont)

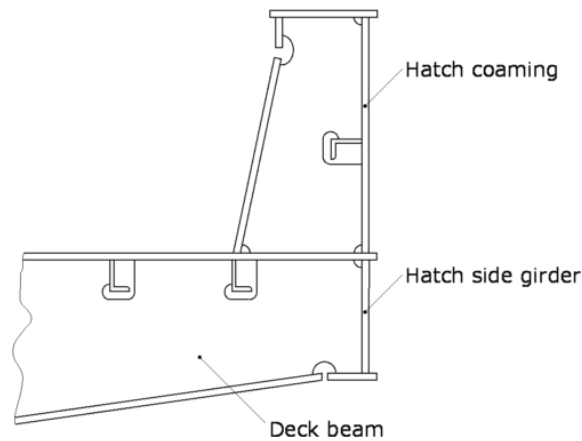

**Fig.10 Example for a hatch side girder**

### 5.4.5 Drainage arrangement at the coaming

If drain channels are provided inside the line of gasket by means of a gutter bar or vertical extension of the hatch side and end coaming, drain openings are to be provided at appropriate positions of the drain channels.

Drain openings in hatch coamings are to be arranged with sufficient distance to areas of stress concentration (e.g. hatch corners, transitions to crane posts).

Drain openings are to be arranged at the ends of drain channels and are to be provided with non-return valves to prevent ingress of water from outside. It is unacceptable to connect fire hoses to the drain openings for this purpose.

If a continuous outer steel contact between cover and ship structure is arranged, drainage from the space between the steel contact and the gasket is also to be provided for.

## 6 Closing arrangements

### 6.1 Securing devices

#### 6.1.1 General

Securing devices between cover and coaming and at cross-joints are to be installed to provide weathertightness. Sufficient packing line pressure is to be maintained.

Securing devices must be appropriate to bridge displacements between cover and coaming due to hull deformations.

Securing devices are to be of reliable construction and effectively attached to the hatchway coamings, decks or covers. Individual securing devices on each cover are to have approximately the same stiffness characteristics.

Sufficient number of securing devices is to be provided at each side of the hatch cover considering the requirements of 3.4.2. This applies also to hatch covers consisting of several parts.

## S21A (cont)

The materials of stoppers, securing devices and their weldings are to be to the satisfaction the individual class society. Specifications of the materials are to be shown in the drawings of the hatch covers.

### 6.1.2 Rod cleats

Where rod cleats are fitted, resilient washers or cushions are to be incorporated.

### 6.1.3 Hydraulic cleats

Where hydraulic cleating is adopted, a positive means is to be provided so that it remains mechanically locked in the closed position in the event of failure of the hydraulic system.

### 6.1.4 Cross-sectional area of the securing devices

The gross cross-sectional area in  $\text{cm}^2$  of the securing devices is not to be less than:

$$A = 0,28 \cdot q \cdot s_{SD} \cdot k_l$$

where:

$q$  = packing line pressure in N/mm, minimum 5 N/mm

$s_{SD}$  = spacing between securing devices in m, not to be taken less than 2 m

$k_l = \left( \frac{235}{\sigma_F} \right)^e$ ,  $\sigma_F$  is the minimum yield strength of the material in  $\text{N/mm}^2$ , but is not to be taken

greater than  $0,7 \cdot \sigma_m$ , where  $\sigma_m$  is the tensile strength of the material in  $\text{N/mm}^2$ .

$e = 0,75$  for  $\sigma_F > 235 \text{ N/mm}^2$

$= 1,00$  for  $\sigma_F \leq 235 \text{ N/mm}^2$

Rods or bolts are to have a gross diameter not less than 19 mm for hatchways exceeding 5  $\text{m}^2$  in area.

Securing devices of special design in which significant bending or shear stresses occur may be designed as anti-lifting devices according to 6.1.5. As load the packing line pressure  $q$  multiplied by the spacing between securing devices  $s_{SD}$  is to be applied.

### 6.1.5 Anti lifting devices

The securing devices of hatch covers, on which cargo is to be lashed, are to be designed for the lifting forces resulting from loads according to 2.4, refer Fig.11. Unsymmetrical loadings, which may occur in practice, are to be considered. Under these loadings the equivalent stress in the securing devices is not to exceed:

$$\sigma_v = \frac{150}{k_l} \text{ in } \text{N/mm}^2$$

**Note:**

*The partial load cases given in Tab. 3 may not cover all unsymmetrical loadings, critical for hatch cover lifting.*

Chapter 5.6 of IACS Rec. 14 should be referred to for the omission of anti lifting devices.

## S21A

(cont)

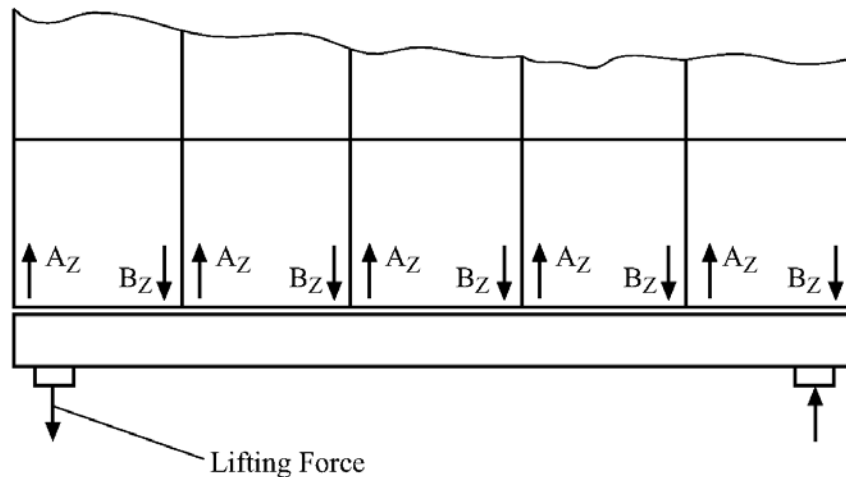

Fig. 11 Lifting forces at a hatch cover

### 6.2 Hatch cover supports, stoppers and supporting structures

#### 6.2.1 Horizontal mass forces

For the design of hatch cover supports the horizontal mass forces  $F_h = m \cdot a$  are to be calculated with the following accelerations:

$$a_x = 0,2 \cdot g \quad \text{in longitudinal direction}$$

$$a_y = 0,5 \cdot g \quad \text{in transverse direction}$$

$$m = \text{Sum of mass of cargo lashed on the hatch cover and mass of hatch cover}$$

The accelerations in longitudinal direction and in transverse direction do not need to be considered as acting simultaneously.

#### 6.2.2 Hatch cover supports

For the transmission of the support forces resulting from the load cases specified in 2 and of the horizontal mass forces specified in 6.2.1, supports are to be provided which are to be designed such that the nominal surface pressures in general do not exceed the following values:

$$p_{n \max} = d \cdot p_n \quad \text{in N/mm}^2$$

$$d = 3,75 - 0,015 L$$

$$d_{\max} = 3,0$$

$$d_{\min} = 1,0 \quad \text{in general}$$

$$= 2,0 \quad \text{for partial loading conditions, see 2.4.1}$$

$$p_n = \text{see Tab.9}$$

For metallic supporting surfaces not subjected to relative displacements the nominal surface pressure applies:

$$p_{n \max} = 3 \cdot p_n \quad \text{in N/mm}^2$$

## S21A (cont)

### Note:

When the maker of vertical hatch cover support material can provide proof that the material is sufficient for the increased surface pressure, not only statically but under dynamic conditions including relative motion for adequate number of cycles, permissible nominal surface pressure may be relaxed at the discretion of the individual classification society. However, realistic long term distribution of spectra for vertical loads and relative horizontal motion should be assumed and agreed with the individual classification society.

Drawings of the supports must be submitted. In the drawings of supports the permitted maximum pressure given by the material manufacturer must be specified.

**Tab. 9 Permissible nominal surface pressure  $p_n$**

Support material	$p_n$ [N/mm <sup>2</sup> ] when loaded by	
	Vertical force	Horizontal force (on stoppers)
Hull structural steel	25	40
Hardened steel	35	50
Lower friction materials	50	–

Where large relative displacements of the supporting surfaces are to be expected, the use of material having low wear and frictional properties is recommended.

The substructures of the supports must be of such a design, that a uniform pressure distribution is achieved.

Irrespective of the arrangement of stoppers, the supports must be able to transmit the following force  $P_h$  in the longitudinal and transverse direction:

$$P_h = \mu \cdot \frac{P_v}{\sqrt{d}}$$

where:

- $P_v$  = vertical supporting force
- $\mu$  = frictional coefficient
- = 0,5 in general

For non-metallic, low-friction support materials on steel, the friction coefficient may be reduced but not to be less than 0,35 and to the satisfaction of the individual class society.

Supports as well as the adjacent structures and substructures are to be designed such that the permissible stresses according to 3.1.1 are not exceeded.

For substructures and adjacent structures of supports subjected to horizontal forces  $P_h$ , fatigue strength is to be considered according to the individual classification society's rules.

## S21A (cont)

### 6.2.3 Hatch cover stoppers

Hatch covers shall be sufficiently secured against horizontal shifting. Stoppers are to be provided for hatch covers on which cargo is carried.

The greater of the loads resulting from 2.2 and 6.2.1 is to be applied for the dimensioning of the stoppers and their substructures.

The permissible stress in stoppers and their substructures, in the cover, and of the coamings is to be determined according to 3.1.1. In addition, the provisions in 6.2.2 are to be observed.

## 7 Corrosion addition and steel renewal

### 7.1 Corrosion addition for hatch covers and hatch coamings

The scantling requirements of the above sections imply the following general corrosion additions  $t_s$ :

**Tab. 10 Corrosion additions  $t_s$  for hatch covers and hatch coamings**

Application	Structure	$t_s$ [mm]
Weather deck hatches of container ships, car carriers, paper carriers, passenger vessels	Hatch covers	1,0
	Hatch coamings	according to individual class society's rules
Weather deck hatches of all other ship types covered by this UR	Hatch covers in general	2,0
	Weather exposed plating and bottom plating of double skin hatch covers	1,5
	Internal structure of double skin hatch covers and closed box girders	1,0
	Hatch coamings not part of the longitudinal hull structure	1,5
	Hatch coamings part of the longitudinal hull structure	according to individual class society's rules
	Coaming stays and stiffeners	1,5

### 7.2 Steel renewal

Steel renewal is required where the gauged thickness is less than  $t_{net} + 0,5$  mm for

- single skin hatch covers,
- the plating of double skin hatch covers, and
- coaming structures the corrosion additions  $t_s$  of which are provided in Tab. 10.

Where the gauged thickness is within the range  $t_{net} + 0,5$  mm and  $t_{net} + 1,0$  mm, coating (applied in accordance with the coating manufacturer's requirements) or annual gauging may be adopted as an alternative to steel renewal. Coating is to be maintained in GOOD condition, as defined in UR Z10.2.1.2.



**S21A**  
(cont)

For the internal structure of double skin hatch covers, thickness gauging is required when hatch cover top or bottom plating renewal is to be carried out or when this is deemed necessary, at the discretion of the individual class society's surveyor, on the basis of the plating corrosion or deformation condition. In these cases, steel renewal for the internal structures is required where the gauged thickness is less than  $t_{net}$ .

For corrosion addition  $t_s = 1,0$  mm the thickness for steel renewal is  $t_{net}$  and the thickness for coating or annual gauging is when gauged thickness is between  $t_{net}$  and  $t_{net} + 0,5$  mm.

For coaming structures, the corrosion additions  $t_s$  of which are not provided in Tab. 10, steel renewal and coating or annual gauging are to be in accordance with the individual classification society's requirements.

End of Document
--------------------