

TÜRK LOYDU

UNIFIED INTERPRETATIONS
for the IMPLEMENTATION of
ILLC 1966 and ILLC 1966-1988



2013

TÜRK LOYDU

Head Office Postane Mah. Tersaneler Cad. No:26 Tuzla 34944 İSTANBUL / TÜRKİYE

Tel : (90-216) 581 37 00

Fax : (90-216) 581 38 00

E-mail : info@turkloydu.org

<http://www.turkloydu.org>

Regional Offices

Ankara Eskişehir Yolu Mustafa Kemal Mah. 2159. Sokak No : 6/4 Çankaya - ANKARA / TÜRKİYE

Tel : (90-312) 219 56 34

Fax : (90-312) 219 68 25

E-mail : ankara@turkloydu.org

İzmir Atatürk Cad. No :378 K.4 D.402 Kavalalılar Apt. 35220 Alsancak - İZMİR / TÜRKİYE

Tel : (90-232) 464 29 88

Fax : (90-232) 464 87 51

E-mail : izmir@turkloydu.org

Adana Çınarlı Mah. Atatürk Cad. Aziz Naci İş Merkezi No:5 K.1 D.2 Seyhan - ADANA / TÜRKİYE

Tel : (90- 322) 363 30 12

Fax : (90- 322) 363 30 19

E-mail : adana@turkloydu.org

Marmaris Atatürk Cad. 99 Sok. No:11 Kat:4 Daire 6 Marmaris - MUĞLA / TÜRKİYE

Tel : (90- 252) 412 46 55

Fax : (90- 252) 412 46 54

E-mail : marmaris@turkloydu.org

TABLE OF CONTENTS

	Page
General Conditions	I
List of Rules	II
Unified Interpretations for the Implementation of ILLC 1966 and ILLC 1966-1988	III

GENERAL CONDITIONS

A. Proviso

Any confirmation or certification of compliance of technical facts or of a product with the Classification and Construction Rules published by Türk Loydu (TL) is due to TL exclusively. Mention of due observance of these regulations during production is permissible solely with the consent of TL.

B. Protective Rights

Application of the Rules of construction of TL does not infringe possible rights for protection of their products on part of the manufacturers.

C. Fees

For services rendered by TL fees are to be paid in accordance with the Tariffs of Fees of TL, even if no classification is granted. In addition to these fees, TL will charge for any extra expenses incurred in connection with the services rendered (e.g. travelling or other expenses and, where applicable, any value added / turnover tax).

D. Payment of Invoices

1. All fees for all services rendered by TL are due for payment immediately upon receipt of the invoice. On default TL is - without prejudice to any further claims (e.g. legal costs, overtime and other expenditure) - entitled to charge interest at a highest rate of rediscount in banking, to withhold certificates and other documents and to withdraw the classification.

2. Any rights of set-off with counter-claims in favour of the client are excluded, unless such counter-claim is undisputed or finally adjudicated upon the courts.

E. Liability

TL will exercise due diligence in selecting their surveyors and all other personnel whose services are employed for the purpose of performing their obligations. But it is to be understood that TL will not be held responsible or liable for any service and its result of any of its surveyors, or other officers. However if any client using the services of TL suffers a loss, damage or expense which is proven to have been caused by the negligent act, omission or default of TL's officers or surveyors towards the client, than the liability of TL to client shall under no circumstances exceed 2 (two) times of the fee charged for that particular service and can not exceed 40.000.- Euro.

F. Jurisdiction

The place of jurisdiction is court of İstanbul Tuzla. The place of performance is Kadıköy. The governing law is Turkish law.

G. Rules

The electronic pdf version of this document found through <http://www.turkloydu.org> is the officially binding version. Any comments may be send by e-mail to tl_rules@turkloydu.org

Part Chapter Title

A	1	Rules for Classification of Steel Ships – Hull
A	2	Rules for Classification of Steel Ships – Materials
A	3	Rules for Classification of Steel Ships – Welding
B	4	Rules for Classification of Steel Ships – Machinery
B	5	Rules for Classification of Steel Ships – Electrical Installation
C	7	High Speed Crafts
C	8	Chemical Tankers
C	9	Rules for Construction and Classification of Yachts
C	10	Liquefied Gas Tankers
C	11	Fire Fighting Ships
C	12	Oil Recovery Vessels
C	13	Escort Tugs
C	14	Fishing Vessels
C	15	Refrigerating Installations
C	16	Pipe Laying Vessels
C	17	Pusher, Pusher/Barge Units
C	18	Drilling Vessels
C	19	Inland Waterway Vessels
C	20	Cable Laying Vessels
C	21	Navigation Bridge Visibility, Bridge Arrangement and Equipment Rules
C	22	Dynamic Positioning Systems
C	23	Redundant Propulsion and Steering Systems
C	24	Chemical Recovery Vessels
C	25	Guidelines for Machinery Condition Monitoring
C	26	Guidelines for the Use of Fuel Cell Systems on Board of Ships and Boats
C	27	Construction of Wooden Passenger Vessels Less than 24 m. in Length
C	28	Ventilation
C	30	Wooden Fishing Vessels
C	32	Rigging for Large Sailing Ships
C	33	Rules for the Construction of Polar Class Ships
D	50	Regulation for Lifting Appliances
D	51	Stowage and Lashing of Containers
D	52	Diving Systems
D	53	Submersibles
D	54	Underwater
D	55	Guidelines for the Construction, Repair and Testing of Freight Containers
D	58	Guidelines for Ocean Towing
D	59	Offshore Technology - Classification, Certification and Surveys
D	60	Offshore Technology - Mobile Offshore Units
D	61	Offshore Technology - Fixed Offshore Installations
D	62	Offshore Technology - Structural Design
D	63	Offshore Technology Machinery Installations
D	64	Offshore Technology – Electrical Installations
D	70	Rules for Multiple Point Mooring Systems
D	75	Guidelines for Corrosion Protection and Coating Systems
D	76	Guidelines for the Environmental Service System
D	77	Guideline for the Certification of Floating Oil Booms
E	101	Naval Ship Technology, Classification and Surveys
E	102	Naval Ship Technology, Hull Structures and Ship Equipment
E	103	Metallic Materials, Special Materials for Naval Ships
E	104	Naval Ship Technology, Propulsion Plants
E	105	Naval Ship Technology, Electrical Installations
E	106	Naval Ship Technology, Automation
E	107	Naval Ship Technology, Ship Operation Installations and Auxiliary Systems
E	111	Naval Ship Technology, Submarines
E	112	Naval Ship Technology, Remotely Operated Underwater Vehicles
E	113	Naval Ship Technology, Guidelines for Air Independent Power Systems for Underwater Use
F	200	Guideline for the Certification of Wind Turbines
F	201	Rules for the Certification of Offshore Wind Turbines
F	202	Guidelines for the Certification of Condition Monitoring Systems for Wind Turbines

UNIFIED INTERPRETATIONS

for the IMPLEMENTATION of

ILLC 1966 and ILLC 1966-1988

LL**1**

(1968)

(Rev.1 July 2008)

Application (Article (4))

Even where the increase in draught is only of the order of 1 in or 2 in there should be no relaxation from the condition that existing ships comply with all the requirements.

Footnote: This UI is also applicable to the revised Article 4 of the 1966 Convention as modified by its 1988 Protocol.

LL**2**

(1968)

(Rev.1 July 2008)

Depth for freeboard (Regulation 3(6))

The correction for thickness of sheathing on the exposed freeboard deck T(L-S)/L is applicable only when deck is completely sheathed between superstructures. In other cases the correction should be Tl/L, where l = length of sheathed area which extends from side to side. Only wood sheathing should be considered.

Footnote: This UI is also applicable to Regulation 3(6) of the 1988 Protocol.

LL**3**

(1968)

(Rev.1 July 2008)

Superstructure (Regulation 3 (10)(b))

A bridge or poop shall not be regarded as enclosed unless access is provided for the crew starting from any point on the uppermost complete exposed deck or higher to reach machinery and other working spaces inside these superstructures by alternative means which are available at all times when bulkhead openings are closed.

Footnote: This UI is also applicable to Regulation 3(10)(b) of the 1988 Protocol.

LL**4**

(1968)

(Rev.1 July 2008)

Details of marking (Regulation 8)

'Permanently marked' is considered to include welding of the marks on the sides of the ship provided the usual precautions as to material, electrodes, etc. are observed.

Footnote: This UI is also applicable to Regulation 8 of the 1988 Protocol and the revised 1988 Protocol.

LL**5**

(1968)

(Rev.1 July 2008)

Doors (Regulation 12)

(a) Doors should generally open outwards to provide additional security against the impact of the sea. Doors which open inwards are to be especially approved.

(b) Portable sills should be avoided. However, in order to facilitate the loading/unloading of heavy spare parts or similar, portable sills may be fitted on the following conditions:

(i) They must be installed before the ship leaves port.

(ii) Sills are to be gasketed and fastened by closely spaced through bolts.

(iii) Whenever the sills are replaced after removal, the weathertightness of the sills and the related doors must be verified by hose testing. The dates of removal, replacing and hose testing shall be recorded in the ship's log book.

Footnotes:

1. This UI is also applicable to Regulation 12 of 1988 Protocol.

2. Paragraph (b)(iii) of this UI is also applicable to Regulation 12 of the revised 1988 Protocol.

LL**6**

(1968)

(Rev.1 May 1999)

(Rev.2 July 2004)

(Rev.3 July 2008)

Hatchways closed by weather tight covers of steel or other equivalent material fitted with gaskets and clamping devices (Regulations 16 and 27(7)(c))

Regulation 16:

Where hatchways are fitted with coamings of standard height, no extra strengthening (beyond what is required in the Load Line Convention) shall be required for covers loaded with cargo, even if dense cargo, provided the load does not exceed 1,75 ton/m² (in position 1)*.

Regulation 27(7)(c):

No extra strengthening is recommended for hatchway covers on vessels* which are assigned freeboards less than those based on Table B, except for flush hatchway covers which are fitted on the freeboard deck forward of the quarter length, in which case the section modulus and the moment of inertia shall be increased 15% over that required by Regulation 16.

*Bulk Carriers:

For the hatch covers on Bulk Carriers, as defined in UR Z11.2.2, contracted for construction on or after 1 July 1998, the hatch cover load and strength requirements are to be in accordance with IACS Unified Requirement S21, "Evaluation of Scantlings of Hatch Covers of Bulk Carrier Cargo Holds".

Note:

1. The "contracted for construction" date means the date on which the contract to build the vessel is signed between the prospective owner and the shipbuilder. For further details regarding the date of "contract for construction", refer to IACS Procedural Requirement (PR) No. 29.

Footnote: This UI is also applicable to Regulations 16 and 27(8)(c) of the 1988 Protocol.

LL**8**

(1968)

(Rev.1 July 2008)

Miscellaneous openings in freeboard and superstructure decks (Regulation 18(2) & 18(3))

1. Regulation 18(2):

(a) Only those doorways in deckhouses leading to or giving access to companionways leading below, need to be fitted with doors in accordance with Regulation 12.

(b) Alternatively, if stairways within a deckhouse are enclosed within properly constructed companionways fitted with doors complying with Regulation 12, the external door need not be watertight.

(c) Where an opening in a superstructure deck or in the top of a deckhouse on the freeboard deck which gives access to a space below the freeboard deck or to a space within an enclosed superstructure is protected by a deckhouse, then it is considered that only those side scuttles fitted in spaces which give direct access to an open stairway need be fitted with deadlights in accordance with Regulation 23. A cabin is considered to provide adequate protection against the minimal amount of water which will enter through a broken side scuttle glass fitted on the second tier.

2. Regulation 18(3):

In the application of Regulation 18 it is understood that:

(i) where access is provided from the deck as an alternative to access from the freeboard deck in accordance with Regulation 3(10)(b) then the height of sills into a bridge or poop should be 380 mm. The same consideration should apply to deckhouses on the freeboard deck.

(ii) where access is not provided from above, the height of the sills to doorways in a poop bridge or deckhouse on the freeboard deck should be 600 mm.

(iii) where the closing appliances of access openings in superstructures and deckhouses are not in accordance with Regulation 12, interior deck openings are to be considered exposed, i.e. situated in the open deck.

Footnotes:

1. This UI is also applicable to Regulation 18(2) and 18(3) of the 1988 Protocol.

2. Paragraphs 1 (c) and 2 (ii) of this UI are also applicable to Regulation 18(2) and (6) of the revised 1988 Protocol respectively.

LL**10**

(1968)

(Rev.1 July 2008)

Air pipes (Regulation 20)

For ships assigned timber freeboards the air pipes should be provided with automatic closing appliances.

Footnote: This UI is also applicable to Regulation 20 of the 1988 Protocol.

LL**11**

(1968)

(Rev.1 1990)

(Rev.2 1994)

(Rev.3 July 2008)

Scuppers, inlets and discharges**(Regulation 22(1))**

It is considered that an acceptable equivalent to one automatic non-return valve with a positive means of closing from a position above the freeboard deck would be one automatic non-return valve and one sluice valve controlled from above the freeboard deck.

Where two automatic non-return valves are required, the inboard valve must always be accessible under service condition, i.e., the inboard valve should be above the level of the tropical load water line. If this is not practicable, then, provided a locally controlled sluice valve is interposed between the two automatic non-return valves, the inboard valve need not to be fitted above the LWL.

Where sanitary discharges and scuppers lead overboard through the shell in way of machinery spaces, the fitting to shell of a locally operated positive closing valve, together with non-return valve inboard, is considered to provide protection equivalent to the requirements of Regulation 22(1).

It is considered that the requirements of Regulation 22(1) for non-return valves are applicable only to those discharges which remain open during the normal operation of a vessel. For discharges which must necessarily be closed at sea, such as gravity drains from topside ballast tanks, a single screw down valve operated from the deck is considered to provide efficient protection.

The inboard end of a gravity discharge which leads overboard from an enclosed superstructure or space is to be located above the water line formed by a 5 degree heel, to port or starboard, at a draft corresponding to the assigned summer freeboard.

It is considered that the position of the inboard end of discharges should be related to the timber summer load waterline when timber freeboard is assigned. Refer to the attached Table for the acceptable arrangements of scuppers, inlets, and discharges. For garbage chutes it is considered that an acceptable equivalent to the non-return valve with a positive means of closing from a position above the freeboard deck would be two gate valves controlled from the working deck of the chute. The lowest gate valve should, in addition, be controlled from a position above the freeboard deck. An interlock system between the two valves should be arranged.

It is recommended that the inboard end be located above the waterline formed by an 8.5 degree heel, to port or starboard, at a draft corresponding to the assigned summer freeboard, but not less than 1000 mm above the summer waterline. Where the inboard end of the garbage chute exceeds 0.01L above the summer waterline, valve control from the freeboard deck is not required, provided the inboard gate valve is always accessible under service conditions.

The distance between the two gate valves should be adequate to allow the smooth operation of the interlock system.

Alternatively, the upper gate valve may be replaced by a hinged weathertight cover at the inboard end of the chute together with a discharge flap which replaces the lower gate valve. The cover and flap are to be arranged with an interlock so that the discharge flap cannot be operated until the hopper cover is closed. The chute is to be constructed of material of substantial thickness up to, and including, the cover. The gate valve(s) controls and/or hinged cover are to be clearly marked: "Keep closed when not in use". Where the inboard end of a garbage chute is below the margin line in a passenger ship, or the critical (crucial) waterline of a cargo ship of more than 100 m in length then:

(i) the inboard end hinged cover/valve is to be watertight.

(ii) the valve is to be a screw-down non-return valve fitted in an easily accessible position above the deepest subdivision load line.

(iii) the screw-down non-return valve is to be controlled from a position above the bulkhead deck and provided with open/shut indicators. The valve control is to be clearly marked: "Keep closed when not in use". Where plastic pipes are used for sanitary discharges and scuppers, they are also subject to the requirements of the Table, and the valve at the shell is to be operated from outside the space in which the valve is located. Where such plastic pipes are located below the summer waterline (timber summer load waterline), the valve is to be operated from a position above the freeboard deck.

The portion of discharge line from the shell to the first valve as well as shell fittings and valves shall be of steel, bronze or other approved ductile material. The approval of plastic piping in any location will be subject to the consideration of strength and fire hazards involved with special reference to penetrations through bulkheads, decks or other significant compartment boundaries. Attention must also be paid to valid fire technical regulations.

Footnote: This UI is also applicable to Regulation 22(1) of the 1988 Protocol.

LL 11- The Table

Discharges coming from enclosed spaces below the freeboard deck or on the freeboard deck			Discharges coming from other spaces		
General requirement Reg. 22(1) where inboard end < 0.01L above SWL	Discharges through machinery spaces	Alternatives (Reg. 22(1)) where inboard end		Outboard end > 450mm below FB deck or < 600mm above SWL Reg. 22(3)	Otherwise Reg. 22(4)
		0.01L above SWL	0.02L above SWL		
<p>Superstructure or Deckhouse Deck</p> <p>FB Deck</p> <p>SWL</p>	<p>SWL</p> <p>SWL</p> <p>SWL</p> <p>SWL</p>	<p>FB Deck</p> <p>SWL</p> <p>SWL</p> <p>SWL</p> <p>SWL</p> <p>SWL</p>	<p>FB Deck</p> <p>SWI</p> <p>SWI</p>	<p>FB Deck</p> <p>SWL</p> <p>SWL</p> <p>SWL</p> <p>SWL</p> <p>SWL</p>	<p>FB Deck</p> <p>SWL</p> <p>SWL</p>
<p>Symbols:</p> <ul style="list-style-type: none"> inboard end of pipes outboard end of pipes pipes terminating on the open deck 		<ul style="list-style-type: none"> non return valve without positive means of closing non return valve with positive means of closing controlled locally valve controlled locally 	<ul style="list-style-type: none"> remote control normal thickness substantial thickness 		
				<p>* / control of the valves are to be in an approved position</p>	

LL**15**

(1968)

(Rev.1 1993)

(Rev.2 July 2003)

(Rev.3 July 2008)

Length of superstructure**(Regulation 34(1) and 34(2))****Regulation 34(1):**

Where a superstructure bulkhead is recessed, the effective length of the superstructure shall be reduced by an amount equivalent in area to the area of the recess related to the breadth of the ship at the mid-length of the recess. Where the recess is unsymmetrical about the centre line, the largest portion of the recess shall be considered as applying to both sides of the ship. It is considered that such a recess need not be decked over. Where a cargo hatchway, complying with the requirements of regulation 16 and having a coaming height that extends above the level of the superstructure deck, is fitted in the recess and covering the whole area of the recess, the hatchway may be taken into account as forming a part of the superstructure, and the effective length of the superstructure need not be reduced by the amount equivalent in area to the area of the recess. The hatchway coaming height shall be in accordance with Regulation 16(1), measured from the superstructure deck level.

Regulation 34(2):

Where there is an extension to a superstructure, which extension has a breadth on each side of the centre line at least 30% of the breadth of the ship, the effective length of the superstructure may be increased by considering an equivalent superstructure bulkhead in the form of a parabola. This parabola should extend from the extension at the centre line and pass through the junction of the actual superstructure bulkhead with the sides of the extension and extend to the sides of the ship. This parabola should be completely contained within the boundary of the superstructure and its extensions.

If the superstructure is set-in from the side, up to the limit allowed under Regulation 3(10), the equivalent bulkhead should be calculated on the basis of the actual breadth of the superstructure (not the breadth of the ship).

Note: Changes introduced in Rev.2 (July 2003) are to be uniformly implemented by IACS Members and Associates from 1 January 2004.

Footnotes:

1. This UI is also applicable to Regulation 34(1) and 34(2) of the 1988 Protocol.

2 Changes introduced in Rev.2 (July 2003) are also applicable to Regulation 34(1) of the revised 1988 Protocol.

LL**16**

(1968)

(Rev.1 July 2008)

Sheer (Regulation 38)

Where the height of a superstructure is less than standard, paragraph 12 may be applied except that the superstructure deck shall not be less than the minimum height of the superstructure above the virtual shear curve at any point.

For this purpose y shall be taken as the difference between the actual and minimum height of the superstructure at the end of sheer.

Footnote: This UI is also applicable to Regulation 38 of the 1988 Protocol.

LL**17**

(1968)

(Corr. 1996)

(Corr.1 June 2006)

(Corr.2 Oct 2007)

(Rev.1 July 2008)

Minimum bow height (Regulation 39(1) and 39(2))

When a ship built on or after 21 July 1968 is arranged to suit exceptional operational requirements such that the forecastle and/or sheer forward do not meet the provisions of paragraphs (1) and (2) of Regulation 39 of the 1966 ICLL, the increase of calculated summer freeboard may, with the concurrence of the Administration, be determined in the following ways.

Nomenclature

$\Delta E_0 \geq 0$	Bow height penalty
$S_{\min} =$	$H_{\min} - fbd_2$
H_{\min}	Minimum bow height calculated according to paragraph (1) of this Regulation
$fbds$	Summer freeboard
$d \leq 0.15L$	Extent of sheer (measured from FP)
$l \leq 0.007L$	Mean covered length of forecastle
h	Height of forecastle measured at FP from zera sheer line
S_{FP}	Actual sheer measured at FP
S_{BHD}	Actual sheer in way of forecastle bulkhead
$S_1 = S_{\min} \left(\frac{0.15L - l_F}{0.15L} \right)^2$	Theoretical sheer in way of forecastle bulkhead corresponding to S_{\min}
$S_1 = h \left(\frac{0.15L - l_F}{0.15L} \right)^2$	Theoretical sheer in way of forecastle bulkhead corresponding h

a) Where no forecastle is fitted and the sheer forward extends less than 0.15 L from fore perpendicular (FP)

$$\Delta E_0 = S_{\min} - S_{FP} \frac{d}{0.15L} = 0$$

$$0 \leq S_{FP} \leq 1.5S_{\min}$$

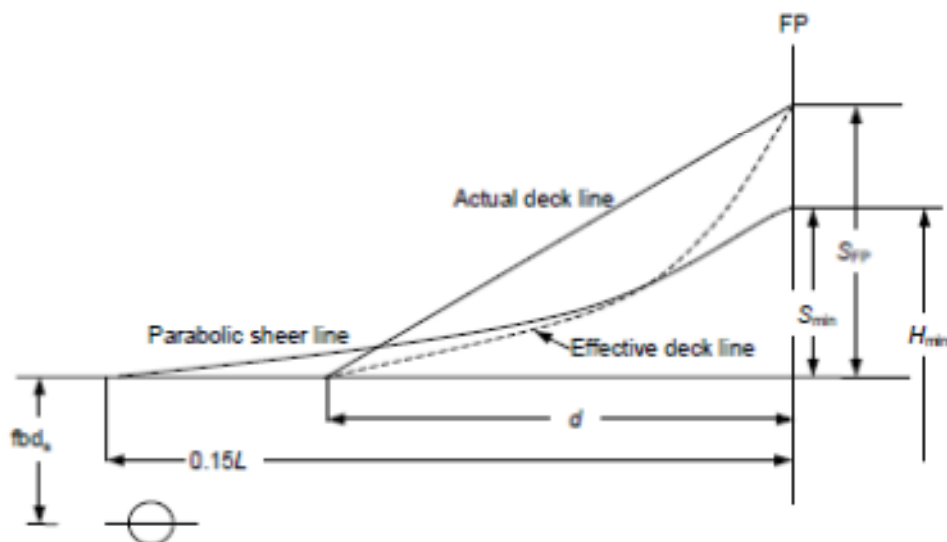

- b) Where there is no sheer on the forward part of the freeboard deck, and the forecastle length is less than $0.007L$ from FP:

$$\Delta E_0 = S_{\min} - h \frac{l_F}{0.07L} \geq 0$$

$$0 \leq h \leq 1.5S_{\min}$$

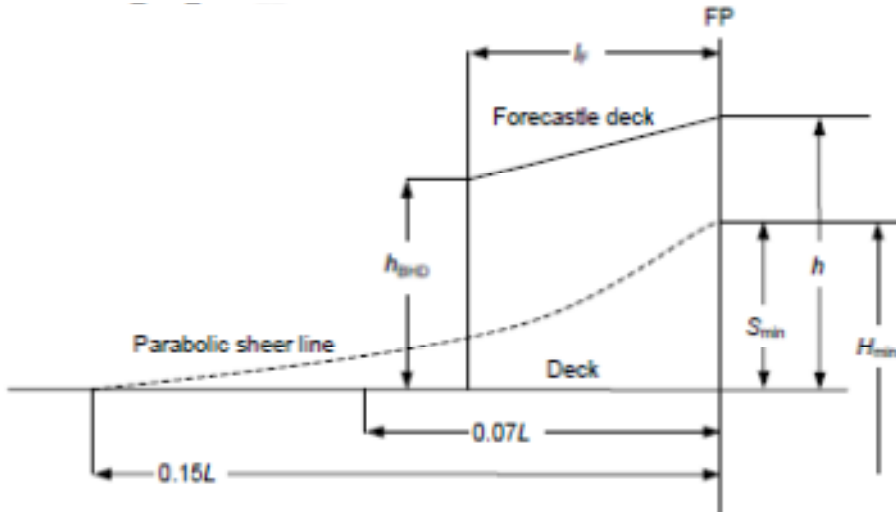

The height of the forecastle at the bulkhead position shall not be less than the ordinate at that point of a parabolic sheer curve having an ordinate S_{\min} at the forward perpendicular and extending aft for a distance of $0.15L$ from the forward perpendicular.

- c) Where the sheer forward extend less than $0.15L$ and the length of forecastle is less than $0.07L$ from FP:

(i) $S_{\min} \leq h \leq 1.5S_{\min}$

$$0 \leq S_{\text{BHD}} \leq 1.5S_1$$

$$\Delta E_0 = S_{\min} \left(1 - \frac{h}{S_{\min}} \frac{l_F}{0.07L} \right) \left(1 - \frac{S_{\text{BHD}}}{S_1} \frac{d - l_F}{0.15L - l_F} \right) = 0$$

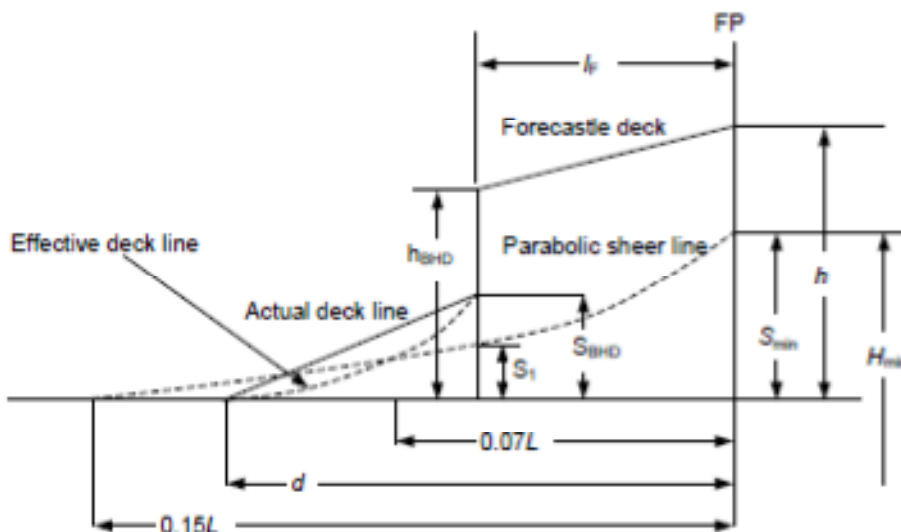

Conditions:

$$\left. \begin{aligned} &\left(1 - \frac{h}{S_{\min}} \frac{l_F}{0.07L}\right) \\ &\left(1 - \frac{S_{\text{BHD}}}{S_1} \frac{d - l_F}{0.15L - l_F}\right) \end{aligned} \right\} \text{not to be taken negative (less than zero)}$$

The height of the forecastle at bulkhead at bulkhead must satisfy the same conditions as in subparagraph (b) of this paragraph.

$$(ii) \quad h \leq S_{\min}$$

$$0 \leq S_{\text{BHD}} \leq 1.5S_2$$

$$\Delta E_o = (S_{\min} - h) + h \left(1 - \frac{l_F}{0.07L}\right) \left(1 - \frac{S_{\text{BHD}}}{S_2} \frac{d - l_F}{0.15L - l_F}\right) \geq 0$$

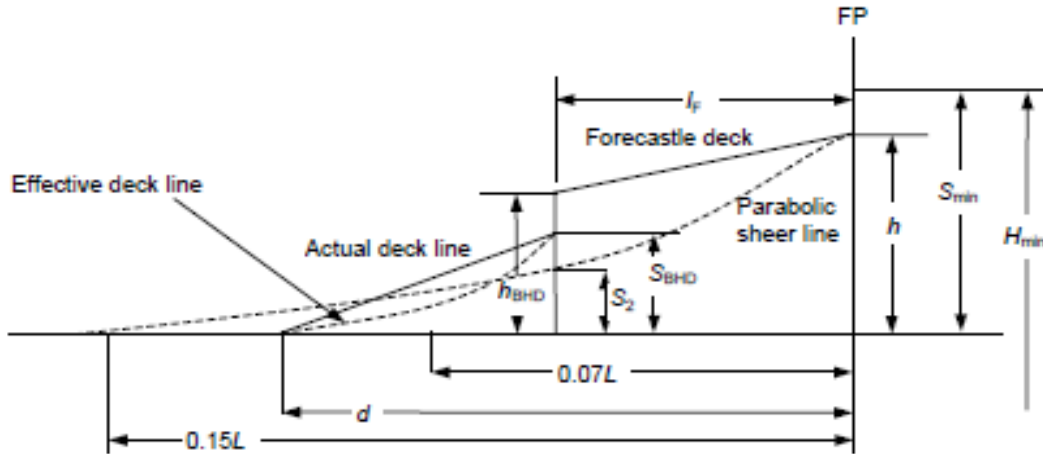
**Conditions:**

$$\left. \begin{aligned} &\left(1 - \frac{l_F}{0.07L}\right) \\ &\left(1 - \frac{S_{\text{BHD}}}{S_2} \frac{d - l_F}{0.15L - l_F}\right) \end{aligned} \right\} \text{not to be taken negative (less than zero)}$$

The height of the forecastle at the bulkhead position shall not be less than the ordinate, at that point, or a parabolic sheer curve having an ordinate h at the forward perpendicular and extending aft for a distance of $0.15L$ from the forward perpendicular.

In general this interpretation should be applied to existing ships only. However, to suit exceptional operational requirements and upon the special consideration by the Administration, the provision of this interpretation may also be applied to new ships.

Note:

This UI may also be applied to Regulation 39(1) and 39(2) of the 1988 Protocol and the revised 1988 Protocol upon the special consideration by the Administration.

LL**18**

(1968)

(Rev.1 July 2008)

Freeboard tables (Regulation 28)**(a) Type A ships**

(i) Freeboards for Type A ships with lengths between 365 m and 400 m shall be determined by the following formula:

$$f = 221 + 16,10L - 0,02L^2$$

where f is the freeboard in mm L is the length as defined in Regulation 3(1).

(ii) Freeboards for Type A ships with lengths of 400 m and above shall be the constant value, 3460 mm.

(b) Type B ships

(i) Freeboards for Type B ships with lengths between 365 m and 400 m shall be determined by the following formula:

$$f = - 587 + 23L - 0,0188L^2$$

where f is the freeboard in mm L is the length as defined in Regulation 3(1).

(ii) Freeboards for Type B ships with lengths of 400 m and above shall be the constant value, 5605 mm.

Footnote: This UI is also applicable to Regulation 28 of the 1988 Protocol and the revised 1988 Protocol.

LL**19**

(1972)

(Rev.1 July 2008)

Form of certificates (Article 18)

It is recommended that the model form of certificates given in Annex III of the Load Line Convention should be strictly adhered to and any deviations from this pattern should be avoided.

Footnote: This UI is also applicable to Article 18 of the 1988 Protocol and the revised 1988 Protocol.

LL**20**

(1972)

(Rev.1 July 2008)

Hatch beams and cover stiffeners of variable cross section (Regulations 15(4), 15(5), 15(6), 15(7) and 16)To avoid stresses and deflections exceeding those given in the above Regulations along construction elements of variable cross section, the required section modulus calculated as for constriction elements of constant cross section is to be increased by a factor K expressed by:

$$K = 1 + \frac{3.2\alpha - \gamma - 0.8}{7 + 0.4}$$

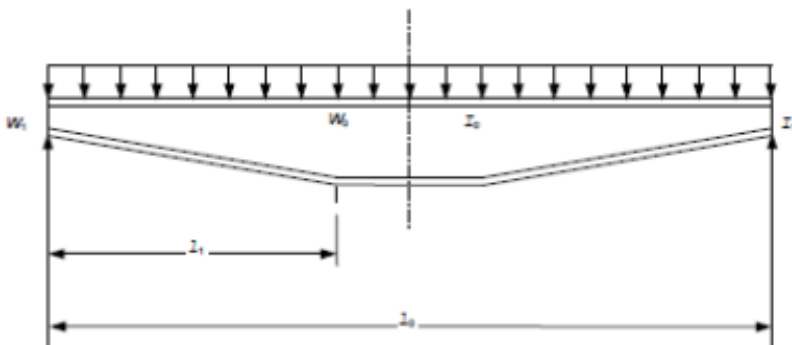
Where $\alpha = l_1/l_0$, $\gamma = W_1/W_0$ The value of factor K obtained by the formula is not to be less than unity. l_1 , l_0 , W_1 and W_0 are indicated on the sketch below:

The moment of inertia is likewise to be increased by the factor C expressed by:

$$C = 1 + 8\alpha^3 \frac{1 - \beta}{0.2 + 3\sqrt{\beta}}$$

Where $\alpha = I_1/I_0$, $\beta = I_1/I_0$

The value factor of C obtained by the formula is not to be less than unity. I_1 and I_0 are indicated on the sketch above. The use of the above formulae is limited to the determination of the strength of hatch beams and covers in which abrupt changes in the section of the face material do not occur along the length of the beam or cover.

Footnote: This UI is also applicable to Regulations 15(4), 15(5), 15(6), 15(7) and 16 of the 1988 Protocol.

LL

21

(1972)

(Rev.1 July 2008)

Cargo ports or similar openings below the uppermost load line (Regulation 21(2))

It is recommended that cargo ports or similar openings may be accepted submerged provided the safety of the ship is in no way impaired. It is considered that the fitting of a second door of equivalent strength and watertightness is one acceptable arrangement. In that case leakage detection device should be provided in the compartment between the two doors. Further, drainage of this compartment to the bilges controlled by an easily accessible screw down valve, should be arranged. The outer door should preferably open outwards.

Footnote: This UI is also applicable to Regulation 21(2) of the 1988 Protocol.

LL

22

(1972)

(Rev.1 July 2008)

Position of the inboard end of discharges when timber freeboard is assigned (Regulation 22(1))

It is considered that the position of the inboard end of discharges should be related to the timber summer load waterline when timber freeboard is assigned.

Footnotes:

1. This UI is also applicable to Regulation 22(1) of the 1988 Protocol.
2. This UI is also applicable to Regulation 22-1 of the revised 1988 Protocol.

LL

23

(1972)

(Rev.1 July 2008)

Freeing arrangement (Regulations 26(5), 27(7) and 36(1)(e))

1. Regulation 27(7): Freeing arrangements on ships having reduced B freeboard assigned and fitted with bulwarks on the freeboard deck For Type B ships with freeboards reduced by not more than 60% of the difference between B and A tables there shall be freeing port area in the lower part of the bulwarks equal to at least 25% of the total area of the bulkwarks. The upper edge of the sheer strake shall be kept as low as possible.

2. Regulations 26(5) and 36(1)(e): Freeing arrangements for Type A ships and Type B ships with trunks It is considered that a freeing port area, in the lower part of the bulwarks, of 33% of the total area of the bulwarks provides the 'other effective freeing arrangements' mentioned in Regulation 26(5), and may be considered equivalent to the 50% open rails in way of trunks required by Regulation 36(1)(e).

Footnotes:

1. This UI is also applicable to Regulations 26(5), 27(8) and 36(1)(e) of the 1988 Protocol.
2. Paragraph 1 of this UI is also applicable to Regulation 27(8) of the revised 1988 Protocol.

LL**24**

(1972)

(Rev.1 July 2008)

Negative depth correction (Regulation 31(3))

When the height of a superstructure, raised quarterdeck or trunk is less than the corresponding standard height, it is recommended that the calculated reduction be corrected in the ratio of the height of the actual superstructure, raised quarterdeck or trunk to the applicable standard height as defined in Regulation 33.

Footnote: This UI is also applicable to Regulation 31(3) of the 1988 Protocol and the revised 1988 Protocol.

LL**25**

(1972)

(Rev.1 July 2008)

Effective length of raised quarterdeck (Regulation 35(4))

It is recommended that the maximum effective length of $0.6L$ of a raised quarterdeck which is stipulated by Regulation 35(4), is to be measured from the after perpendicular even where a poop is fitted in conjunction with the raised quarterdeck.

Footnote: This UI is also applicable to Regulation 35(4) of the 1988 Protocol.

LL**26**

(1972)

Rev.1 1983)

(Rev.2 July 2008)

Continuous hatchways as trunk (Regulation 36)

It is recommended that continuous hatchways may be treated as a trunk in the freeboard computation provided Regulation 36 is complied with in all respects. The trunk deck stringer referred to in Regulation 36(1)(b) may be fitted outboard of the trunk side bulkhead in association with the following:

- (i) The stringer so formed is to provide a clear walkway of at least 450 mm in width on each side of the ship.
- (ii) The stringer is to be of solid plate efficiently supported and stiffened.
- (iii) The stringer is to be as high above the freeboard deck as practicable. In the freeboard calculation, the trunk height is to be reduced by at least 600 mm or by the actual difference between the top of the trunk and the stinger, whichever is greater.
- (iv) Hatch cover securing appliances are to be accessible from the stringer or walkway.
- (v) The breadth of the trunk is to be measured between the trunk side bulkheads.
- (vi) Regulation 36 is to be complied with in all other respects.

Footnote: This UI is also applicable to Regulation 36 of the 1988 Protocol.

LL**27**

(1972)

(Rev.1 July 2008)

Less than standard hatch coamings on trunks of less than standard height (Regulation 36(4))

In the case where the trunk height is less than standard and the trunk hatch coamings are also of less than standard height, or omitted entirely, doubt may arise whether the trunk hatchways are located in position 1 or position 2 and, consequently, about the reduction to be made in the actual trunk height. It is considered that in these cases the reduction from the actual height of trunk on account of insufficient hatch coaming height shall be taken as the difference between 600 mm and the actual height of coaming, or 600 mm if no hatch coamings are fitted. Reduction in the actual height of trunk shall not be required in cases where only small hatches with less than standard height coamings are fitted in the trunk deck for which dispensation from the requirement of standard coaming height may be given.

Footnote: This UI is applicable to Regulation 36(4) of the 1988 Protocol.

LL**28**

(1972)

(Rev.1 July 2008)

Deduction for superstructures and trunks (Regulations 37 and 38(12))

For the purpose of applying the table 'Percentage of Deduction for Type B ships' in Regulation 37(2) it is considered that any detached superstructure abaft midship whose after bulkhead is located $0.05L$ or more forward of the after perpendicular may be treated as a detached bridge. A superstructure whose after bulkhead is located within $0.05L$ from the after perpendicular shall not qualify as a detached bridge.

Any excess in the height of such a superstructure, which does not extend to the after perpendicular, cannot be regarded as contributing to the sheer allowance contemplated in Regulation 38(12).

Footnote: This UI is applicable to Regulations 37 and 38(12) of the 1988 Protocol.

LL**29**

(1972)

(Rev.1 1983)

(Rev.2 July 2008) (cont)

Sheer Credit for Superimposed Superstructures (Regulation 38(5), 38(7) and 38(12))

(a) **Regulation 38(5):** Superstructures superimposed on a complete superstructure.

In applying Regulation 38(5) (sheer on a complete superstructure ship) where there is an enclosed poop or forecastle superimposed on a complete superstructure, sheer credit shall be allowed for such a poop or forecastle, according to the method of Regulation 38(12) as shown in Fig 1.

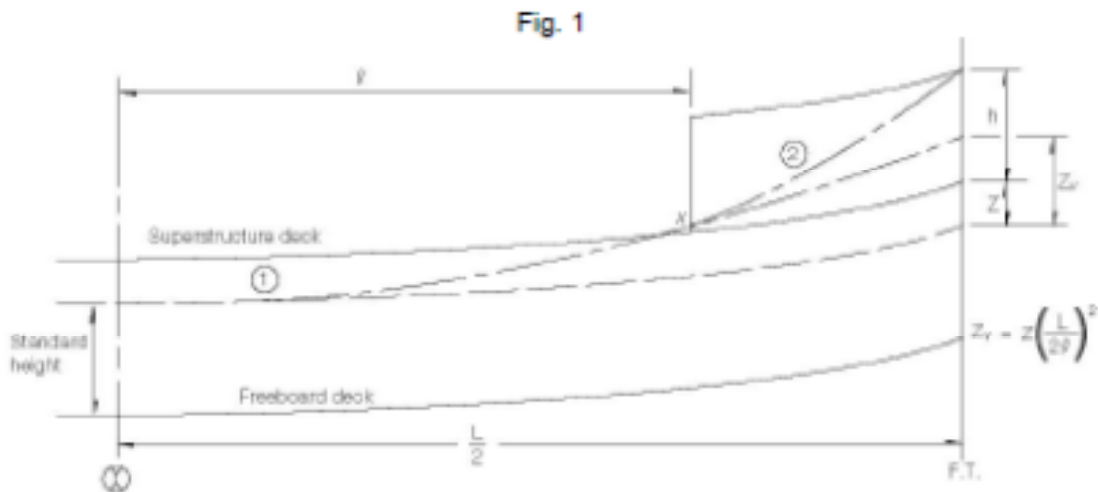

(b) **Regulation 38(7):** Superstructures superimposed on a forecastle or poop (i.e. a stepped forecastle or poop).

In applying Regulation 38(7) and 38(12) where a poop or forecastle consists of two layers, the method shown in Fig 2 shall be used:

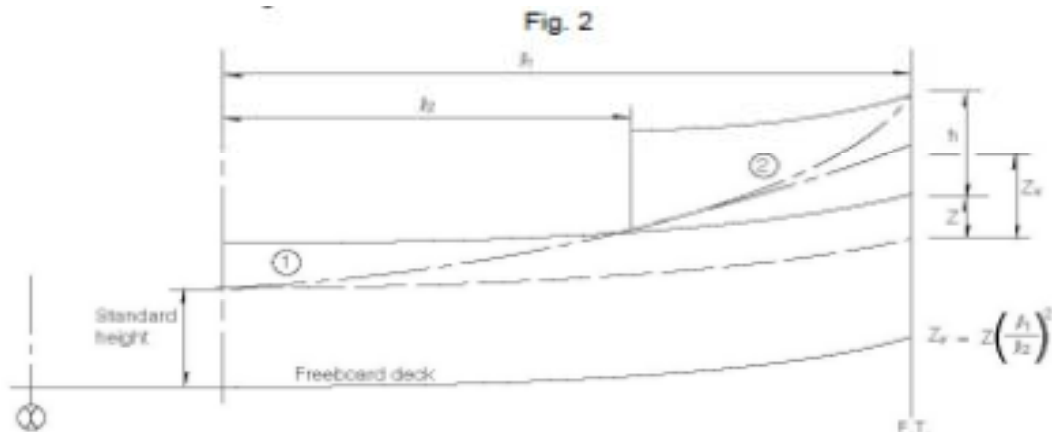

Footnote: This UI is applicable to Regulations 38(5), 38(7) and 38(12) of the 1988 Protocol.

In the above the following definitions apply:

Z is as per Regulation 38(5).

Z_v is the end ordinate of a virtual standard parabolic curve taken through the point "X". If Z_v is greater than (Z+h), the end ordinate shall be (Z+h), in which case point "X" shall be disregarded and curve (2) not taken into account.

When the length of the first tier superstructure is greater than 0.5L, the virtual standard parabolic curve shall commence at amidships as indicated in Fig 1.

LL

30

(1972)

(Rev.1 July 2008)

Sheer allowance for excess height of superstructure (Regulations 38(7) and 38(12))

As Regulation 38(7) and (12) does not refer to a raised quarter deck it is recommended that credit under this paragraph be given for this type of superstructure only when the height of the raised quarterdeck is greater than the standard height of 'other superstructures' as defined in Regulation 33, and only for the amount by which the actual height of the raised quarterdeck exceeds that standard height.

Footnote: This UI is applicable to Regulations 38(7) and 38(12) of the 1988 Protocol.

LL

31

(1972)

(Rev.1 July 2008)

Deduction for excess sheer (Regulation 38(15))

Since no stipulation is made as to the height of the superstructure referred to in Regulation 38(15), it is recommended that the height of this superstructure shall be related to its standard height. When the height of the superstructure or raised quarterdeck is less than standard, the reduction shall be in the ratio of the actual to the standard height thereof.

Footnote: This UI is applicable to Regulation 38(15) of the 1988 Protocol.

LL

33

(1972)

(Rev.1 July 2008)

Timber freeboards for ships having reduced Type B freeboards assigned (Regulations 45(2) and 45(3))

It is understood that some Administrations accept that timber freeboards may be assigned to ships with reduced Type B freeboards, provided the timber freeboards are calculated on the basis of the ordinary Type B freeboard.

It is recommended that Regulation 45(2) and (3) is interpreted or, if necessary, amended such that the Timber Winter mark and/or the Timber Winter North Atlantic mark are placed at the same level as the reduced Type B Winter mark when the computed Timber Winter mark and/or the computed Timber Winter North Atlantic mark fall below the reduced Type B Winter mark.

Footnote: This UI is applicable to Regulations 45(2) and 45(3) of the 1988 Protocol.

LL

34

(1972)

(Corr.1 July 2008)

Freeboard for lighters and barges (Regulation 27(11) of 1966 ILLC)

In applying Regulation 27(11) to deck cargo barges it is recommended that only Type B freeboard can be assigned, even if the barges possess the same integrity of exposed decks and equivalent safety against flooding as normal tank barges.

This view is taken as a result of the consideration that Type A freeboard can only be assigned to liquid cargo barges.

It is further concluded that deck cargo can only be carried on barges to which Type B freeboard is assigned.

LL**35**

(1972)

(Corr.1 July 2008)

Stowage of timber deck cargo on ships having timber freeboards assigned (Regulations 44 and 45)

It is recommended that for the purpose of applying Regulation 45 the timber deck cargo shall extend as far outboard as possible due allowance being given for obstructions such as guard rails, stanchions, uprights, etc.

LL**36**

(1975)

(Rev.1 1978)

(Rev.2 July 2008)

Minimum wall thickness of pipes (Regulations 19, 20 and 22)

For pipes covered by the above Regulations the following minimum wall thicknesses are recommended:

(a) (i) For scupper and discharge pipes, where substantial thickness is not required; and

(ii) For venting pipes other than specified under (c):

- external diameter of pipes equal to or less than 155 mm: thickness not less than 4,5 mm

- external diameter of pipes equal to or more than 230 mm: thickness not less than 6,0 mm intermediate sizes are to be determined by linear interpolation.

(b) For scupper and discharge pipes where substantial thickness is required:

- external diameter of pipes equal to or less than 80 mm: thickness not less than 7,0 mm

- external diameter of pipes 180 mm: thickness not less than 10,0 mm

- external diameter of pipes equal to or more than 220 mm: thickness not less than 12,5 mm intermediate sizes are to be determined by linear interpolation.

(c) For venting pipes in position 1 and 2 leading to spaces below the freeboard deck or to spaces within enclosed superstructures:

- external diameter of pipes equal to or less than 80 mm: thickness not less than 6,0 mm

- external diameter of pipes equal to or more than 165 mm: thickness not less than 8,5 mm intermediate sizes are to be determined by linear interpolation.

Footnotes:

1. This UI is also applicable to Regulations 19, 20 and 22 of the 1988 Protocol.

2. Paragraphs (a)(ii) and (c) are also applicable to Regulations 19 and 20 of the revised 1988 Protocol.

LL**37**

(1975)

(Rev.1 1983)

(Corr. 1996)

(Rev.2 July 2008)

Superstructures with sloping end bulkheads (Regulations 34, 35 and 38(12))

When taking account of superstructures which have sloping end bulkheads in the calculations of freeboards, such superstructures shall be dealt with in the following manner:

(a) Regulation 34

(i) When the height of the superstructure, clear of slope, is equal to or smaller than the standard height, length S is to be obtained as shown in Fig. 1.

(ii) When the height is greater than the standard, length S is to be obtained as shown in Fig 2.

(iii) The foregoing will apply only when the slope, related to the base line, is 15° or greater.

Where the slope is less than 15°, the configuration will be treated as sheer.

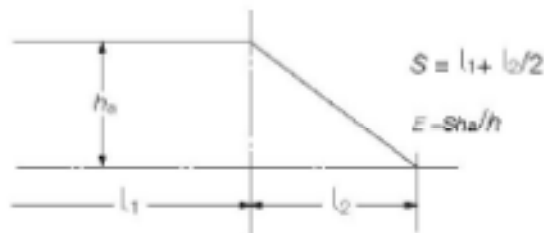

Fig. 1 Height of superstructure equal to or smaller than the standard height.

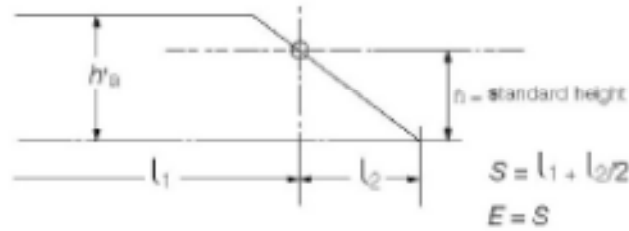

Fig. 2 Height of superstructure greater than the standard height.

(b) Regulation 35

When the height of the superstructure, clear of the slope, is less than the standard height, its effective length E shall be its length S as obtained from (a)(i), reduced in the ratio of the actual height to the standard height.

(c) Regulation 38(12)

When a poop or a forecastle has sloping end bulkheads, the sheer credit may be allowed on account of excess height, the formula given in Regulation 38(12) shall be used, the values for y and L' being as shown in Fig 3.

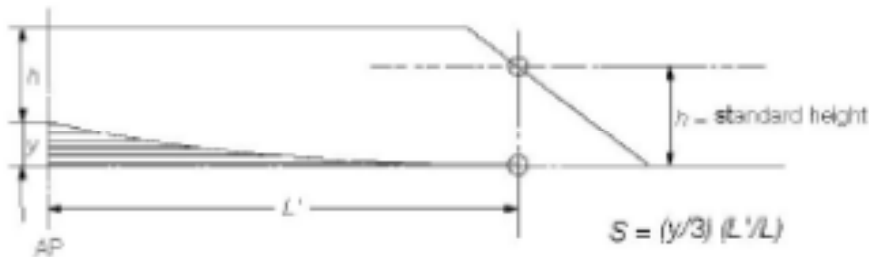

Fig. 3 Sheer credit s for excess height.

Footnote: This UI is also applicable to Regulations 34, 35 and 38(12) of the 1988 Protocol.

LL

38

(1976)
 (Rev.1 1983)
 (Corr.1 Jun 2006)
 (Rev.2 July 2008)

Bow Height (Regulation 39(2))

1. When calculating bow height, the sheer of the forecastle deck may be taken into account, even if the length of the forecastle is less than 0.15L, but greater than 0.07L, provided that the forecastle height is not less than one half of standard height of superstructure as defined in Regulation 33 between 0.07L and the forward terminal.
2. Where the forecastle height is less than one half of standard height of superstructure, as defined in Regulation 33, the credited bow height may be determined as follows (Figs 1 and 2 illustrate the intention of 2.1 and 2.2 respectively):
 - 2.1 When the freeboard deck has sheer extending from abaft 0.15L, by a parabolic curve having its origin at 0.15L abaft the forward terminal at a height equal to the midship depth of the ship, extended through the point of intersection of forecastle bulkhead and deck, and up to a point at the forward terminal not higher than the level of the forecastle deck. However, if the value of the height denoted h_t on Fig 1 is smaller than the value of the height denoted h_b , then h_t may be replaced in the available bow height.
 - 2.2 When the freeboard deck has sheer extending for less than 0.15L or has no sheer, by a line from the forecastle deck at side at 0.07L extended parallel to the base line to the forward terminal.

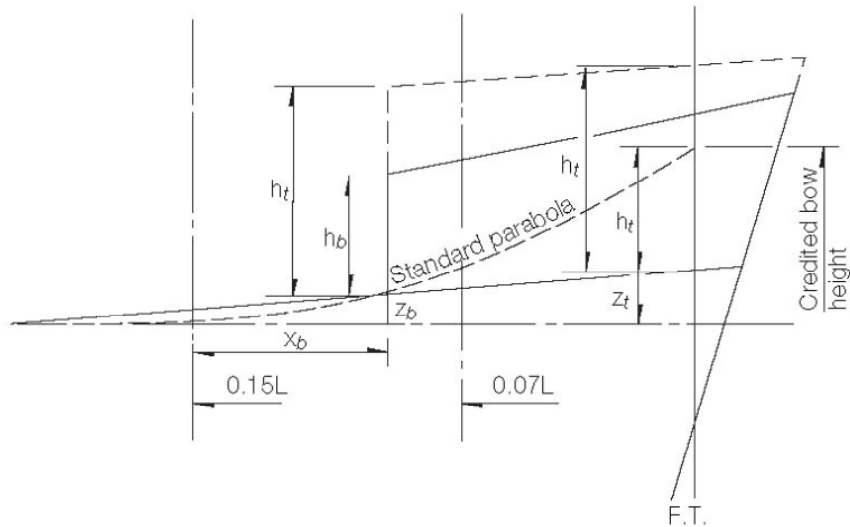

Fig. 1

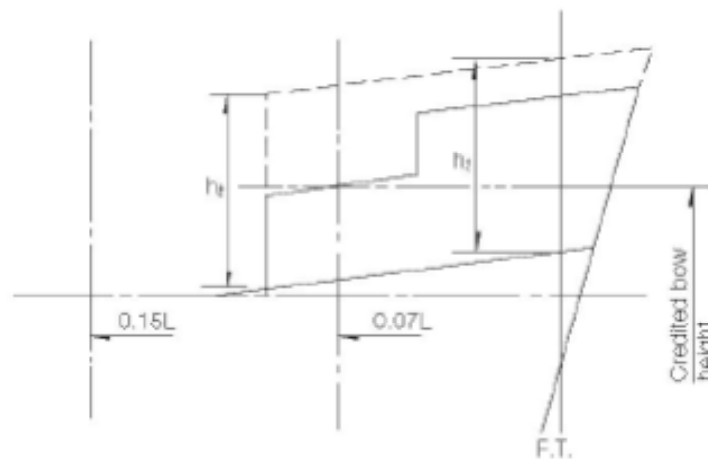

Fig. 2

h_1 = Half standard height of superstructure as defined in regulation 33.

$$h_t = Z_0 \left(\frac{0.15L}{x_0} \right) - Z_t$$

Footnote: This UI is applicable to Regulation 39(2) of the 1988 Protocol.

LL

39

(1977)

(Rev.1 July 2008)

Structure of a lower freeboard deck (Regulation 3(9))

When a lower deck is designated as the freeboard deck, it shall be continuous in fore and aft direction as well as athwartships. Such a freeboard deck as a minimum shall consist of suitable framed stringers at the ship sides and transversely at each watertight bulkhead which extends to the upper deck, within cargo spaces. The width of these stringers shall not be less than can be conveniently fitted having regard to the structure and the operation of the ship.

Any arrangement of stringers shall be such that structural requirements can also be met.

NOTE

Member Societies formulated this Interpretation in order to have a guide when judging whether a structure below the uppermost complete deck can be designated as a freeboard deck in terms of Regulation 3(9) for the application of tonnage regulations. This was done, although it is obvious that such a structure has no significance with regard to the philosophy of the Load Line Convention. Nevertheless it is felt that it would be preferable if tonnage and load line matters

could be clearly separated by deleting from the Load Line Convention the reference to a lower deck being designated as the freeboard deck.

Footnote: This UI is also applicable to Regulation 3(9) of the 1988 Protocol.

LL**40**

(1977)

(Rev.1 1980)

(Rev.2 July 2008)

Security of hatch covers (Regulation 15(13))

Acceptable equivalent means to steel bars shall consist of devices and materials which will provide strength equivalent to, and elasticity not greater than that of, steel. Steel wire ropes cannot be regarded as satisfactory equivalent means.

Care is to be taken that tarpaulins are adequately protected from the possibility of damage arising from the use of securing devices which do not provide a flat bearing surface.

Footnotes:

1. This UI is also applicable to Regulation 15(13) of the 1988 Protocol.

2. This UI is also applicable to Regulation 15(12) of the revised 1988 Protocol.

LL**41**

(1978)

(Rev.1 July 2008)

Trunks (Regulations 29, 36 and 38)

(a) Where the length of a trunk, corrected for breadth and height as may be appropriate, can be included in the effective length used for calculating the correction for superstructures in accordance with Regulation 37, it shall not be taken into account for calculating the total length S for the purpose of sheer correction according to Regulation 38(13).

(b) The effective length of superstructures E which is used for calculating the freeboard correction according to Regulation 29 shall be determined excluding the length of trunks.

(c) The inclusion of a trunk in the calculation of freeboard need not prohibit the fitting of openings in the bulkheads of adjacent superstructures such as poops, bridges or forecastles provided there is no direct communication between the superstructure and the trunk.

(d) The sides of a trunk included in the calculations of freeboard shall be intact. Side scuttles of the non-opening type and bolted manhole covers may be allowed.

Footnote: This UI is also applicable to Regulations 29, 36 and 38 of the 1988 Protocol

LL**42**

(1978)

(Rev.1 July 2008)

Access openings on barges (Regulation 27(11))

(a) Since Regulation 27(11) does not contain any indication as to what size the term 'small access openings' refers it is recommended that such openings should not be greater than $1,5 \text{ m}^2$ where a freeboard reduction of 25% is granted.

(b) Access plates are considered as being equivalent to an intact deck for unmanned barges, thereby allowing for a 25% reduction in freeboard, provided they are secured by closely spaced bolts, their joining parts are properly gasketed and their arrangements, for all practical purposes, have equivalent structural integrity and tightness as an intact deck.

Footnote: This UI is also applicable to Regulation 27(14)(c) of the 1988 Protocol and the revised 1988 Protocol.

LL**44**

(1978)

(Rev.1 July 2008)

Freeing ports (Regulation 24(3))

The effectiveness of the freeing area in bulwarks required by Regulation 24(1) and (2) depends on free flow across the deck of a ship. Where there is no free flow due to the presence of a continuous trunk or hatchway coaming, the freeing area in bulwarks is calculated in accordance with Regulation 24(3).

The free flow area on deck is the net area of gaps between hatchways, and between hatchways and superstructures and deck houses up to the actual height of the bulwark. The freeing port area in bulwarks should be assessed in relation to the net flow area as follows:

i. If the free flow area is not less than the freeing area calculated from Regulation 24(3) as if the hatchway coamings were continuous, then the minimum freeing port area calculated from Regulation 24(1) and (2) should be deemed sufficient.

ii. If the free flow area is equal to, or less than the area calculated from Regulations 24(1) and (2), then the minimum freeing area in the bulwarks should be determined from Regulation 24(3).

iii. If the free flow area is smaller than that calculated from Regulation 24(3), but greater than that calculated from Regulation 24(1) and (2), the minimum freeing area in the bulwark should be determined from the following formula:

$$F = F1 + F2 - fp \text{ (m}^2\text{)}$$

where $F1$ is the minimum freeing area calculated from Regulations 24(1) and (2), $F2$ is the minimum freeing area calculated from Regulation 24(3), fp is the total net area of passages and gaps between hatch ends and superstructures or deckhouses up to the actual height of bulwark.

Footnote: This UI is also applicable to Regulation 24(3) of the 1988 Protocol

LL

45

(1978)

(Rev.1 1984)

(Rev.2 Aug 2008)

Presentation of stability data (Regulation 10(2))

Regulation 10(2) of 1966 Convention and 1988 Protocol requires that:

"The master of every new ship which is not already provided with stability information under an international convention for the safety of life at sea in force shall be supplied with sufficient information in an approved form to give him guidance as to the stability of the ship under varying conditions of service, and a copy shall be furnished to the Administration."

Regulation 10(2) of the revised 1988 Protocol requires that:

"Information shall be provided to the master in a form that is approved by the Administration or a recognised organization. Stability information, and loading information also related to ship strength when required under paragraph (1), shall be carried on board at all times together with evidence that the information has been approved by the Administration."

Interpretation

To ensure that ships are provided with meaningful information which accords with the sense of Regulation 10(2) a document containing such information is to be prepared on the basis of MSC Circular 920. Additionally full details of the stability criteria appropriate to the ship under all anticipated conditions of service shall be clearly stated in text supplemented as necessary by diagrams using the nomenclature adopted in the document. Where requirements for wind and/or wave forces and ice accretion are specified by the administration full details are to be given.

Footnotes:

1. Rev.2 of this Unified Interpretation is to be applied by all Members and Associates on ship with a contract for construction on or after 1 September 2008.
2. The "contracted for construction" date means the date on which the contract to build the vessel is signed between the prospective owner and the shipbuilder. For further details regarding the date of "contract for construction", refer to IACS Procedural Requirement (PR) No. 29.

LL

46

(1979)

(Rev.1 1980)

(Rev.2 1997)

(Rev.3 July 2008)

Protection of openings in raised quarterdecks (Regulation 18(2) and Interpretation LL8)

Regarding the requirement to protect openings in superstructures (Regulation 18(2)) it is considered that openings in the top of a deckhouse on a raised quarterdeck, or on the deck of a superstructure or on the deck of a deckhouse of less than standard height, having a height equal to or greater than the standard quarterdeck height are to be provided with an acceptable means of closing but need not be protected by an efficient deckhouse or companionway as defined in the regulation provided the height of the deckhouse is at least the height of superstructure.

Footnote: This UI is also applicable to Regulation 18(2) of the 1988 Protocol.

LL**47**

(1979)

(Rev.1 1980)

(Rev.2 June 2006)

(Rev.2.1 Oct 2006)

(Corr.1 Oct 2007)

(Rev.3 July 2008)

Guard Rails**Content**

A. Guard Rails (Regulation 25(2) and (3) of 1966 ICLL and the 1988 Protocol)

B. Guard Rails (Regulation 25(3)(b) of the 1988 Protocol to the ICLL 1966 as amended by resolution MSC.143(77))****

A. Guard Rails (Regulation 25(2) and (3) of 1966 ICLL and the 1988 Protocol)

Regulation 25(2) and (3) of 1966 ICLL read:

(2) Efficient guard rails or bulwarks shall be fitted to all exposed parts of the freeboard and superstructure decks. The height of the bulwarks or guard rails shall be at least 1 m (39 inches) from the deck, provided that where this height would interfere with the normal operation of the ship, a lesser height may be approved if the Administration is satisfied that adequate protection is provided.

(3) The opening below the lowest course of the guard rails shall not exceed 230 mm (9 inches). The other courses shall be not more than 380 mm (15 inches) apart. In the case of ships with rounded gunwales the guard rail supports shall be placed on the flat of the deck.

Interpretation

(a) Fixed, removable or hinged stanchions shall be fitted about 1,5 m apart.

(b) At least every third stanchion shall be supported by a bracket or stay. In lieu of this, flat steel stanchions shall be of increased breadth as given in Figure 1, and aligned with member below deck unless the deck plating thickness exceeds 20 mm.

(c) Wire ropes may only be accepted in lieu of guard rails in special circumstances and then only in limited lengths.

(d) Lengths of chain may only be accepted in lieu of guard rails if they are fitted between two fixed stanchions and/or bulwarks.

(e) The openings between courses should be in accordance with Regulation 25(3) of the Convention.

(f) Wires shall be made taut by means of turnbuckles.

(g) Removable or hinged stanchions shall be capable of being locked in the upright position.

Note:

1. Rev.2 was withdrawn in Nov 2006, to remove ambiguity in referencing relevant regulations.

2. Rev.2.1 of this UI is to be uniformly applied by IACS Societies to ships contracted for construction on or after 1 April 2007. However, Societies are not precluded from applying this UI before such date.

3. The "contracted for construction" date means the date on which the contract to build the vessel is signed between the prospective owner and the shipbuilder. For further details regarding the date of "contract for construction", refer to IACS Procedural Requirement (PR) No. 29.

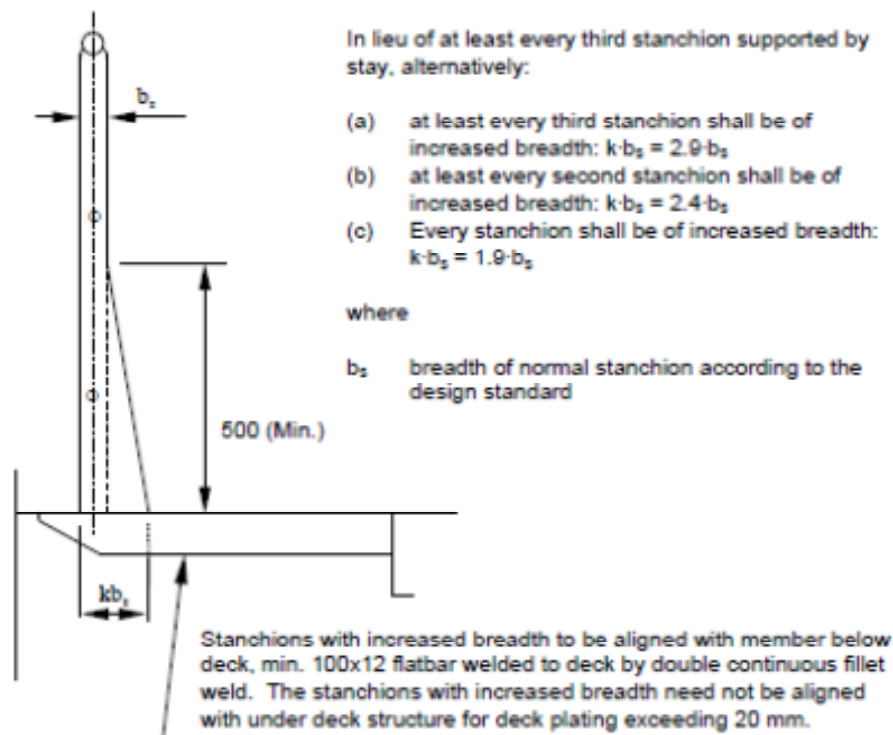

Fig. 1 Guardrail stanchion of increased breadth, welded to deck with double continuous fillet weld with leg size of min. 7 mm or as specified by the design standard.

******Guard Rails (Regulation 25(3)(b) of the 1988 Protocol to the ICLL 1966 as amended by resolution MSC.143(77))**

Regulation 25(3)(b) of the 1988 Protocol to the ICLL 1966 as amended by resolution MSC.143(77) reads:

(b) At least every third stanchion shall be supported by a bracket or stay.

Interpretation

As alternate arrangements (required by Regulation 25(3)(b)), flat steel stanchions shall be of increased breadth as given in Figure 1, and aligned with member below deck unless the deck plating thickness exceeds 20 mm.

LL

48

(1980)

(Rev.1 1983)

(Rev.2 July 2008)

Moulded Depth (Regulation 3(5)(c) and 3(9) and Freeboard Calculation (Regulation 40(1))

Discontinuous Freeboard Deck, Stepped Freeboard Deck.

1. Where a step exists in the freeboard deck, creating a discontinuity extending over the full breadth of the ship, and this step is in excess of one metre in length, Reg 3(9) shall apply. (Fig 1). A step one metre or less in length shall be treated as a recess in accordance with paragraph 2.
2. Where a recess is arranged in the freeboard deck, and this recess does not extend to the side of the ship, the freeboard calculated without regard to the recess is to be corrected for the consequent loss of buoyancy. The correction would be equal to the value obtained by dividing the volume of the recess by the waterplane area of the ship at 85% of the least moulded depth. (Fig 2).
- 2.1 The correction would be a straight addition to the freeboard obtained after all other corrections have been applied, except bow height correction.
- 2.2 Where the freeboard, corrected for lost buoyancy as above, is greater than the minimum geometric freeboard determined on the basis of a moulded depth measured to the bottom of the recess, the latter value may be used.
3. Recesses in a second deck, designated as the freeboard deck, may be disregarded in this Interpretation provided all openings in the weather deck are fitted with weathertight closing appliances.
4. Due regard is to be given to the drainage of exposed recesses and to free surface effects on stability.
5. This Interpretation is not intended to apply to dredgers, hopper barges or other similar types of ships with large open holds, where each case would require individual consideration.

Fig. 1 (Para. 1)

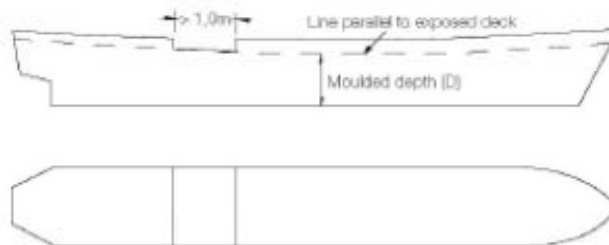
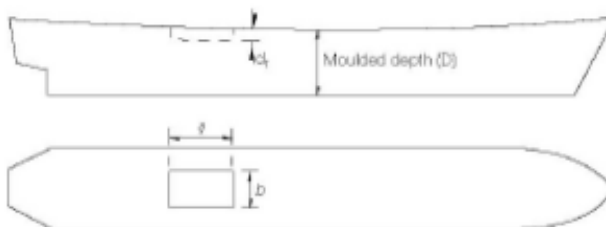

Fig. 2 (Para. 2)



Correction is addition to freeboard equal to:

$$\frac{l \times b \times d_1}{WP \text{ Area} @ 0,85D}$$

Footnotes:

1. This UI is also applicable to Regulations 3(5)(c), 3(9) and 40(1) of 1988 Protocol.

2 Paragraph 1 should be replaced with the following sentence: "A step one metre or less in length shall be treated as a recess in accordance with Reg. 32-1." when this UI applies to the revised 1988 Protocol. Paragraphs from 2 to 5 are not applicable to the revised 1988 Protocol.

LL**49**

(1980)

(Rev.1 July 2008)

Air pipe closing devices (Regulation 20)

Where required by Regulation 20 air pipe closing devices shall be weathertight. Closing devices shall be automatic if, while the vessel is at its draught corresponding to summer load line, the openings of air pipes to which these closures are fitted submerge at angles up to 40° or up to a lesser angle which may be agreed on the basis of stability requirements. Pressurevacuum valves (PV valves) may, however, be accepted on tankers. Wooden plugs and trailing canvas hoses shall not be accepted in position 1 and position 2.

NOTE

The Member Societies in formulating this interpretation realise that pressure-vacuum valves (PV valves) presently installed on tankers do not theoretically provide complete watertightness. In view, however, of experience of this type of valve and the position in which they are normally fitted it was considered they could be accepted.

Footnotes:

1. This UI is also applicable to Regulation 20 of 1988 Protocol.
2. The first and last sentences of this UI are also applicable to Reg.20(3) of the revised 1988 Protocol.

LL**51**

(1983)

(Rev.1 1986)

(Rev.2 July 2008)

Freeboards greater than minimum (Regulation 2(5))

Where freeboards are required to be increased, because of such consideration as strength (Regulation 1), location of shell doors (Regulation 21) or side scuttles (Regulation 23) or other reasons then:

(a) the height of

- door sills Regulation 12
- hatchway coamings Regulation 15(1)
- sills of machinery space openings Regulation 17
- miscellaneous openings Regulation 18
- ventilators Regulation 19
- air pipes Regulation 20

(b) the scantlings of hatch covers Regulation 15 and 16,

(c) freeing arrangements Regulation 24 and means for protection of crew Regulation 25,

(d) windows and side scuttles on the actual freeboard deck may be as required for a superstructure deck, provided the summer freeboard is such that the resulting draught will not be greater than that corresponding to the minimum freeboard calculated from an assumed freeboard deck situated at a distance equal to a standard superstructure height below the actual freeboard deck. Similar considerations may be given in cases of draught limitation on account of bow height (Regulation 39).

Footnote: This UI is also applicable to Regulation 2(5) of 1988 Protocol

LL**52**

(1983)

(Rev.1 July 2008)

Weathertight closing appliances for ventilators (Regulation 19(4))

Where required by Regulation 19, weathertight closing appliances for all ventilators in positions 1 and 2 are to be of steel or other equivalent materials. Wood plugs and canvas covers are not acceptable in these positions.

Footnote: This UI is also applicable to Regulation 19(4) of 1988 Protocol

LL**53**

(1987)

(Rev.1 July 2008)

Treatment of moonpools

Where moonpools are arranged within the hull in open communication with the sea, the volume of the moonpool should not be included in calculation of any hydrostatic properties. An addition should be made to the geometric freeboard, if the moonpool has a larger crosssectional area above the waterline at 0,85D than below, corresponding to the lost buoyancy. This addition for the excess portion above 0,85D should be made as prescribed for recesses in LL 48/rev 1.

If an enclosed superstructure contains part of the moonpool, deduction should be made from the effective length of the superstructure.

Footnotes:

1. This UI is also applicable to 1988 Protocol.
2. The reference "LL 48/rev 1" should be replaced with "Reg.32-1" when this UI applies to the revised 1988 Protocol.

LL

54

(1989)

(Rev.1 July 2008)

Effective length of superstructures (Regulation 35(3))

When calculating the freeboard for a ship with excessive sheer but without any superstructure at 0,2L amidships, the deduction for sheer per Regulation 38(15) is not to be granted. However, where a poop or forecastle of less than standard height is fitted, when applying Regulation 35(3), credit may be given to the height of the poop or forecastle by increasing it by the difference between the actual and the standard sheer profiles.

When the height of the superstructure, clear of the slope, is less than the standard height, its effective length E shall be its length S as obtained from (a)(i), reduced in the ratio of the actual height to the standard height.

Footnote: This UI is also applicable to Regulation 35(3) of the 1988 Protocol.

LL

55

(1993)

(Rev.1 July 2008)

Least Moulded Depth for a Ship with a Rake of Keel (Regulation 3(1))

For a ship with a rake of keel, least moulded depth, D_{mld} , is found by drawing a line parallel to the keel line of the vessel (including skeg) tangent to the moulded sheer line of the freeboard deck, as illustrated in the above sketch. The least moulded depth is the vertical distance measured from the top of the keel to the top of the freeboard deck beam at side at the point of tangency.

Depth for freeboard, D , may then be found.

Footnote: This UI is also applicable to Regulation 3(1) of the 1988 Protocol

LL

56

(1993)

(Rev.1 July 2008)

Block Coefficient of a Pontoon (Regulation 3(7))

When calculating the block coefficient of a pontoon, according to the definition of Regulation 3(7), the 96%-length, if applicable, shall be used disregarding the fact that this might lead to a coefficient greater than 1,0.

Footnote: This UI is also applicable to Regulation 3(7) of the 1988 Protocol.

LL

57

(1996)

(Rev.1 July 2008)

Block Coefficient of a Multi-hull Craft (Regulation 3(7))

When calculating the block coefficient (C_b) of a multi-hull craft according to the definition of Regulation 3(7), the full breadth (B) as defined in regulation 3(4) is to be used and not the breadth of a single hull.

Footnote: This UI is also applicable to Regulation 3(7) of the 1988 Protocol.

LL**58**

(1997)

(Rev.1 July 2008)

Machinery space and emergency generator room ventilator coaming heights (Regulations 17(2), 19(3) and 19(4))

Regulation 17(2) requires that the coamings of machinery space ventilators situated in exposed positions on the freeboard and superstructure decks be as high above the deck as is reasonable and practicable.

In general, ventilators necessary to continuously supply the machinery space and, on demand, immediately supply the emergency generator room should have coamings which comply with regulation 19(3), without having to fit weathertight closing appliances.

However, where due to vessel size and arrangement this is not practicable, lesser heights for machinery space and emergency generator room ventilator coamings may be accepted with provision of weathertight closing appliances in accordance with regulation 19(4) in combination with other suitable arrangements to ensure an uninterrupted, adequate supply of ventilation to these spaces.

Footnote: This UI is also applicable to Regulations 17(2), 19(3) and 19(4) of the 1988 Protocol.

LL**59**

(1997)

(Rev.1 Dec 2007)

Cargo manifold gutter bars – freeing arrangements and intact stability (ICLL Regulation 24(1)(g) and Regulation 26)**ICLL 1988, as amended by res. MSC.143(77), Regulation 24 Freeing Ports**

(1)(g) Gutter bars greater than 300 mm in height fitted around the weather decks of tankers in way of cargo manifolds and cargo piping shall be treated as bulwarks. Freeing ports shall be arranged in accordance with this regulation. Closures attached to the freeing ports for use during loading and discharge operations are to be arranged in such a way that jamming cannot occur while at sea.

ICLL 1966, Regulation 26 Special Conditions of Assignment for Type "A" Ships**Machinery Casings**

(1) Machinery casings on Type "A" ships as defined in Regulation 27 shall be protected by an enclosed poop or bridge of at least standard height, or by a deckhouse of equal height and equivalent strength, provided that machinery casings may be exposed if there are no openings giving direct access from the freeboard deck to the machinery space. A door complying with the requirements of Regulation 12 may, however, be permitted in the machinery casing, provided that it leads to a space or passageway which is as strongly constructed as the casing and is separated from the stairway to the engine room by a second weathertight door of steel or other equivalent material.

Gangway and Access

(2) An efficiently constructed fore and aft permanent gangway of sufficient strength shall be fitted on Type "A" ships at the level of the superstructure deck between the poop and the midship bridge or deckhouse where fitted, or equivalent means of access shall be provided to carry out the purpose of the gangway, such as passages below deck. Elsewhere, and on Type "A" ships without a midship bridge, arrangements to the satisfaction of the Administration shall be provided to safeguard the crew in reaching all parts used in the necessary work of the ship.

(3) Safe and satisfactory access from the gangway level shall be available between separate crew accommodations and also between crew accommodations and the machinery space.

Hatchways

(4) Exposed hatchways on the freeboard and forecastle decks or on the tops of expansion trunks on Type "A" ships shall be provided with efficient watertight covers of steel or other equivalent material.

Freeing Arrangements

(5) Type "A" ships with bulwarks shall have open rails fitted for at least half the length of the exposed parts of the weather deck or other effective freeing arrangements. The upper edge of the sheer strake shall be kept as low as practicable.

(6) Where superstructures are connected by trunks, open rails shall be fitted for the whole length of the exposed parts of the freeboard deck.

ICLL 1988, Regulation 26 Special conditions of assignment for type 'A' ships**Machinery casings**

(1) Machinery casings on type 'A' ships, as defined in regulation 27, shall be protected by one of the following arrangements:

(a) an enclosed poop or bridge of at least standard height; or

(b) a deckhouse of equal height and equivalent strength.

(2) Machinery casings may, however, be exposed if there are no openings giving direct access from the freeboard deck to the machinery space. A door complying with the requirements of regulation 12 is acceptable in the machinery casing, provided that it leads to a space or passageway which is as strongly constructed as the casing and is separated from the stairway to the engine-room by a second weathertight door of steel or other equivalent material.

Gangway and access

(3) A fore-and-aft permanent gangway, constructed in accordance with the provisions of regulation 25-1(2)(e), shall be fitted on type 'A' ships at the level of the superstructure deck between the poop and the midship bridge or deckhouse where fitted. The arrangement contained in regulation 25-1(2)(a) is considered an equivalent means of access to carry out the purpose of the gangway.

(4) Safe access from the gangway level shall be available between separate crew accommodations and also between crew accommodations and the machinery space.

Hatchways

(5) Exposed hatchways on the freeboard and forecastle decks or on the tops of expansion trunks on type 'A' ships shall be provided with efficient watertight covers of steel or other equivalent material.

Freeing arrangements

(6) Type 'A' ships with bulwarks shall have open rails fitted for at least half the length of the weather deck or other equivalent freeing arrangements. A freeing port area, in the lower part of the bulwarks, of 33% of the total area of the bulwarks, is an acceptable equivalent freeing arrangement. The upper edge of the sheer strake shall be kept as low as practicable.

(7) Where superstructures are connected by trunks, open rails shall be fitted for the whole length of the exposed parts of the freeboard deck.

Interpretation

Where gutter bars are installed on the weather decks of tankers in way of cargo manifolds and are extended aft as far as the after house front for the purpose of containing cargo spills on deck during loading and discharge operations, the free surface effects caused by containment of a cargo spill during liquid transfer operations or of boarding seas while underway require consideration with respect to the vessel's available margin of positive initial stability (GMO).

Where the gutter bars installed are greater than 300 mm in height, they are to be treated as bulwarks according to the Load Line Convention with freeing ports arranged in accordance with Regulation 24 and effective closures provided for use during loading and discharge operations. Attached closures are to be arranged in such a way that jamming cannot occur while at sea, ensuring that the freeing ports will remain fully effective.

On ships without deck camber, or where the height of the installed gutter bars exceeds the camber, and for tankers having cargo tanks exceeding 60% of the vessel's maximum beam at midships regardless of gutter bar height, gutter bars should not be accepted without an assessment of the initial stability (GMO) for compliance with the relevant intact stability requirement taking into account the free surface effect caused by liquids contained by the gutter bars.

Note:

1. Rev.1 of this Unified Interpretation is to be uniformly implemented by all Members and Associates from 1 July 2008, unless otherwise instructed by a Flag State.

LL

60

(1997)

(Corr.1 April 1998)

(Rev.1 July 2008)

Freeing ports in way of wells in combination with open superstructures (Regulation 24(1) and 24(4))

In the case of vessels having open superstructures on the freeboard or superstructure decks, which open to wells formed by bulwarks on the peripheries of the open decks, the convention leaves to the satisfaction of the Administration how the freeing port areas for the open spaces within the superstructures are to be calculated.

Since water can enter only through the end bulkhead openings, the freeing port areas for the open spaces within the superstructures should be a function of the breadth of the end openings and the extent to which wells formed by the open decks and common spaces within the open superstructures are covered by the open superstructures.

To determine the minimum freeing port area on each side of the ship for the open superstructure (A_S) and for the open well (A_W), the following procedure is recommended:

1. Determine the total well length (l_t) equal to the sum of the length of the open deck enclosed by bulwarks (l_w) and the length of the common space within the open superstructure (l_s).

2. To determine (A_S):

2.1 Calculate the freeing port area (A) required for an open well of length l_t in accordance with regulation 24(1) with standard height bulwark assumed.

2.2 Multiply by the factor of 1.5 to correct for the absence of sheer, if applicable, in accordance with regulation 24(2).

2.3 Multiply by the factor (b_o/l_t) to adjust the freeing port area for the breadth (b_o) of the openings in the end bulkhead of the enclosed superstructure. (Note: this cancels the l_t terms from the calculation.)

2.4 To adjust the freeing port area for that part of the entire length of the well which is enclosed by the open superstructure, multiply by the factor:

$1-(l_w/l_t)^2$ where l_w and l_t are defined in 1 above.

2.5 To adjust the freeing port area for the distance of the well deck above the freeboard deck, multiply by the factor:

$0.5 (h_s/h_w)$ where h_w is the distance of the well deck above the freeboard deck and h_s is one standard superstructure height.

3. To determine (A_W):

3.1 The freeing port area for the open well (A_W) is to be calculated in accordance with step

2.1 above, using l_w to calculate (A'), and then adjusted for the actual height of the bulwark (h_b) by the application of one of the following area corrections, whichever is applicable:

For bulwarks greater than 1.2 m in height:

$$A_C = l_w ((h_b - 1.2) / (0.10)) (0.004) \text{ m}^2$$

For bulwarks less than 0.9 m in height:

$$A_C = l_w ((h_b - 0.9) / (0.10)) (0.004) \text{ m}^2$$

For bulwarks between 1.2 m and 0.9 m in height:

$$A_C = 0.00 \text{ m}^2$$

3.2 The corrected freeing port area, ($A_W = A' + A_C$), is then adjusted for absence of sheer, if applicable, and height above freeboard deck as in steps 2.2 and 2.5 above, using h_S and h_W .

4. The resulting freeing port areas for the open superstructure (A_S) and for the open well (A_W) are to be provided along each side of the open space covered by the open superstructure and each side of the open well respectively.

5. The above relationships are summarised by the following equations, assuming l_t , the sum of l_W and l_S , is greater than 20 m*:

Freeing port area A_W for the open well:

$$A_W = (0.07 l_W + A_C) \text{ (sheer correction)} (0.5h_S/h_W)$$

Freeing port area A_S for the open superstructure:

$$A_S = (0.07 l_t) \text{ (sheer correction)} (b_C/l_t) (1 - (l_W/l_t)^2) (0.5h_S/h_W)$$

* Where l_t is 20 m or less, the basic freeing port area is $A = 0.7 + 0.035l_t$ in accordance with Regulation 24(1). Units are to be consistent with those in the Convention.

Footnote: This UI is also applicable to Regulation 24(1) and 24(4) of the 1988 Protocol.

LL

61

(1997)

(Rev.1 July 2008)

Method of correction for the effect of free surface of liquids in tanks (Regulation 10(2), UR L3 and UI LL45)

1 For all loading conditions, the initial metacentric height and the righting lever curve should be corrected for the effect of free surfaces of liquids in tanks.

2 Free surface effects will exist whenever the filling level in a tank is less than 100% and greater than 0%. Where the total free surface effects of nominally full (i.e. 98% or above) tanks is small in relation to the metacentric height of the vessel, with the agreement of the administration the effects for such tanks may be ignored. Free surface effects should be considered whenever the filling level in a tank is less than 98%.

3 Tanks which are taken into consideration when determining the free surface correction may be in one of two categories:

3.1 Tanks with filling levels fixed (e.g. liquid cargo, water ballast). The free surface correction should be determined for the actual filling level to be used in each tank.

3.2 Tanks with filling levels variable (e.g. consumable liquids such as fuel oil, diesel oil, and fresh water, and also liquid cargo and water ballast during liquid transfer operations). Except as permitted in 5 and 6, the free surface correction should be the maximum value attainable between the filling limits envisaged for each tank, consistent with any operating instructions.

4 In calculating the free surface effects in tanks containing consumable liquids, it should be assumed that for each type of liquid at least one transverse pair or a single centreline tank has a free surface and the tank or combination of tanks taken into account should be those where the effect of free surfaces is the greatest.

5 Where water ballast tanks, including anti-rolling tanks and anti-heeling tanks, are to be filled or discharged during the course of a voyage, the free surface effects should be calculated to take account of the most onerous transitory stage relating to such operations.

6 For vessels engaged in liquid transfer operations, the free surface corrections at any stage of the liquid transfer operations may be determined in accordance with the filling level in each tank at that stage of the transfer operation.

7 The corrections to the initial metacentric height and to the righting lever curve should be addressed separately as follows:

7.1 In determining the correction to initial metacentric height, the transverse moments of inertia of the tanks should be calculated at 0 degrees angle of heel according to the categories indicated in 3.

7.2 The righting lever curve may be corrected by any of the following methods subject to the agreement of the Administration:

.1 Correction based on the actual moment of fluid transfer for each angle of heel calculated.

.2 Correction based on the moment of inertia, calculated at 0 degrees angle of heel, modified at each angle of heel calculated, (i.e.: $GG_1 \sin \theta$).

.3 Correction based on the summation of M_{fs} values for all tanks taken into consideration, see 8.

With the exception of item 7.2.3 above, corrections may be calculated according to the categories indicated in 3.

Whichever method is selected for correcting the righting lever curve, only that method should be presented in the vessel's stability booklet. However, where an alternative method is described for use in manually calculating loading conditions, an explanation of the differences which may be found in the results, as well as an example correction for each alternative, should be included.

8 The values of M_{fs} for each tank may be derived from the formula:

$$M_{fs} = vbpk\sqrt{\delta}$$

Where:

- M_{ts} is the free surface moment at any inclination in metre-tonnes
 v is the tank total capacity in cubic metres
 b is the tank maximum breadth in metres
 ρ is the mass density of liquid in the tank in tones/cubic metre
 δ is equal to v/blh (the tank block coefficient)
 h is the tank maximum height in metres
 l is the tank maximum length in metres
 k is the dimensionless coefficient to be determined from the following table according to the ratio b/h . The intermediate values are determined by interpolation.

Table of Values for Coefficient "k" for Calculating Free Surface Corrections

		$k = \frac{\sin \theta}{12} \left(1 + \frac{\tan^2 \theta}{2} \right) \cdot \frac{b}{h}$														
		where $\cot \theta = \frac{b}{h}$														
		$k = \frac{\cos \theta}{8} \left(1 + \frac{\tan \theta}{b/h} \right) - \frac{\cos \theta}{12(b/h)^2} \left(1 + \frac{\cot^2 \theta}{2} \right)$														
		where $\cot \theta = \frac{b}{h}$														
θ	b/h	5°	10°	15°	20°	30°	40°	45°	50°	60°	70°	75°	80°	85°	θ	b/h
	20	0.11	0.12	0.12	0.12	0.11	0.10	0.09	0.09	0.07	0.05	0.04	0.03	0.02	20	20
	10	0.07	0.11	0.12	0.12	0.11	0.10	0.10	0.09	0.07	0.05	0.04	0.03	0.02	10	10
	5	0.04	0.07	0.10	0.11	0.11	0.11	0.10	0.10	0.08	0.07	0.06	0.05	0.04	5	5
	3	0.02	0.04	0.07	0.09	0.11	0.11	0.11	0.10	0.09	0.08	0.07	0.06	0.05	3	3
	2	0.01	0.03	0.04	0.06	0.09	0.11	0.11	0.11	0.10	0.09	0.09	0.08	0.07	2	2
	1.5	0.01	0.02	0.03	0.05	0.07	0.10	0.11	0.11	0.11	0.11	0.10	0.10	0.09	1.5	1.5
	1	0.01	0.01	0.02	0.03	0.05	0.07	0.09	0.10	0.12	0.13	0.13	0.13	0.13	1	1
	0.75	0.01	0.01	0.02	0.02	0.04	0.05	0.07	0.08	0.12	0.15	0.15	0.16	0.16	0.75	0.75
	0.5	0.00	0.01	0.01	0.02	0.02	0.04	0.04	0.05	0.09	0.16	0.18	0.21	0.23	0.5	0.5
	0.3	0.00	0.00	0.01	0.01	0.01	0.02	0.03	0.03	0.05	0.11	0.19	0.27	0.34	0.3	0.3
	0.2	0.00	0.00	0.00	0.01	0.01	0.01	0.02	0.02	0.04	0.07	0.13	0.27	0.45	0.2	0.2
	0.1	0.00	0.00	0.00	0.00	0.00	0.01	0.01	0.01	0.02	0.04	0.06	0.14	0.53	0.1	0.1

9 Small tanks which satisfy the following condition using the values of "k" corresponding to an angle of inclination of 30 degrees, need not be included in the correction:

$$vbpk\sqrt{\delta} / \Delta_{\min} < 0.01m$$

Where Δ_{\min} = the minimum ship displacement in tonnes

10. The usual remainder of liquids in empty tanks need not be taken into account in calculating the corrections providing the total of such residual liquids does not constitute a significant free surface effect.

Footnote: This UI is also applicable to Regulation 10(2) of the 1988 Protocol and the revised 1988 Protocol.

LL

62

(1997)

(Rev.1 July 2008)

(Corr.1 Aug 2010)

Side Scuttles, Windows and Skylights (Regulation 23)

(1) Side scuttles and windows together with their glasses, deadlights¹ and storm covers, if fitted, shall be of approved design and substantial construction in accordance with, or equivalent to, recognised national or international standards. Non-metallic frames are not acceptable.

(2) Side scuttles are defined as being round, or oval, openings with an area not exceeding 0.16 square metres. Round or oval openings having areas exceeding 0.16 square metres shall be treated as windows.

(3) Windows are defined as being rectangular openings generally, having a radius at each corner relative to the window size in accordance with recognised national or international standards, and round, or oval, openings with an area exceeding 0.16 square metres.

(4) Side scuttles to the following spaces shall be fitted with efficient hinged inside deadlights:

- (a) spaces below freeboard deck
- (b) spaces within the first tier of enclosed superstructures
- (c) first tier deckhouses on the freeboard deck protecting openings leading below or considered buoyant in stability calculations.

The deadlights shall be capable of being effectively closed and secured watertight if fitted below freeboard deck and weathertight if fitted above.

(5) Side scuttles shall not be fitted in such a position that their sills are below a line drawn parallel to the freeboard deck at side and having its lowest point 2.5 percent of the breadth B, or 500 mm, whichever is the greatest distance, above the summer load line (or timber summer load line if assigned).

(6) Side scuttles shall be of the non-opening type in ships subject to damage stability regulations, if calculations indicate that they would become immersed by any intermediate stage of flooding or the final equilibrium waterplane in any required damage case.

(7) Windows shall not be fitted below the freeboard deck, in the first tier end bulkheads or sides of enclosed superstructures and in first tier deckhouses² considered buoyant in the stability calculations or protecting openings leading below.

(8) Side scuttles and windows at the side shell in the second tier, protecting direct access below or considered buoyant in the stability calculations, shall be provided with efficient hinged inside deadlights capable of being effectively closed and secured weathertight.

(9) Side scuttles and windows set inboard from the side shell in the second tier, protecting direct access below to spaces listed in paragraph (4), shall be provided with either efficient hinged inside deadlights or, where they are accessible, permanently attached external storm covers of approved design and of substantial construction and capable of being effectively closed and secured weathertight.

(10) Cabin bulkheads and doors in the second tier separating side scuttles and windows from a direct access leading below may be accepted in place of deadlights or storm covers fitted to the side scuttles and windows.

(11) Deckhouses situated on a raised quarter deck or on the deck of a superstructure of less than standard height or on the deck of a deckhouse of less than standard height, may be regarded as being in the second tier as far as the provision of deadlights is concerned, provided the height of the raised quarter deck, superstructure or deckhouse is equal to, or greater than, the standard quarter deck height.

(12) Fixed or opening skylights shall have glass thickness appropriate to their size and position as required for side scuttles and windows. Skylight glasses in any position shall be protected from mechanical damage and where fitted in positions 1 or 2, shall be provided with robust deadlights or storm covers permanently attached.

¹ 'Deadlights', in accordance with recognised standards, are fitted to the inside of windows and side scuttles while 'storm covers', of comparable specifications to deadlights, are fitted to the outside of windows, where accessible, and may be hinged or portable.

² Two members reserved their position for those cases where this first tier is not considered buoyant, provided efficient deadlights are fitted.

Footnotes:

1. This UI is also applicable to Regulation 23 of the 1988 Protocol.
2. Paragraph 7 of this UI is applicable to Reg. 23(7)(c) of the revised 1988 Protocol.
3. Paragraph 11 of this UI is applicable to Reg. 23(11) of the revised 1988 Protocol.

LL

63

(July 1998)

(Rev.1 July 2004)

(Rev.2 July 2008)

Treatment of steps and recesses in transverse subdivision bulkheads: IMO Res. A.320 (IX), paragraphs 12(d) and 12(e), and Regulation 27(12)(d) and (e), Revised 1988 ICLL (MSC.143(77)) Regulation 27, paragraphs 12(d) of 1988 ICLL as amended by Res. MSC.143(77) reads:

"Except where otherwise required by paragraph (10)(a), the flooding shall be confined to a single compartment between adjacent transverse bulkheads, provided that the inner longitudinal boundary of the compartment is not in a position within the transverse extent of assumed damage. Transverse boundary bulkheads of wing tanks, which do not extend over the full breadth of the ship shall be assumed not to be damaged, provided that they extend beyond the transverse extent of assumed damage prescribed in subparagraph (b). If in a transverse bulkhead there are steps or recesses of not more than 3 m in length, located within the transverse extent of assumed damage as defined in subparagraph (b), such transverse bulkhead may be considered intact and the adjacent compartment may be floodable singly. If, however, within the transverse extent of assumed damage there is a step or recess of more than 3 m in length in a transverse bulkhead, the two compartments adjacent to this bulkhead shall be considered as flooded. The step formed by the afterpeak bulkhead and the afterpeak tank top shall not be regarded as a step for the purpose of this regulation."

Regulation 27, paragraphs 12(e) of 1988 ICLL as amended by Res. MSC.143(77) reads:

"Where a main transverse bulkhead is located within the transverse extent of assumed damage and is stepped in way of a double bottom or side tank by more than 3 m, the double bottom or side tanks adjacent to the stepped portion of the main transverse bulkhead shall be considered as flooded simultaneously. If this side tank has openings into one or several holds, such as grain feeding holes, such hold or holds shall be considered as flooded simultaneously. Similarly, in a ship designed for the carriage of fluid cargoes, if a side tank has openings into adjacent compartments, such adjacent compartments shall be considered as empty and as being flooded simultaneously. This provision is applicable even

where such openings are fitted with closing appliances, except in the case of sluice valves fitted in bulkheads between tanks and where the valves are controlled from the deck. Manhole covers with closely spaced bolts are considered equivalent to the unpierced bulkhead, except in the case of openings in topside tanks making the topside tanks common to the holds.”

Interpretation

Where a transverse bulkhead forming the forward or aft limit of a wing tank or double bottom tank is not in line with the main transverse bulkhead of the adjacent in board compartment, it is considered to form a step or recess in the main transverse bulkhead.

Such a step or recess should be assumed not to be damaged provided that, either:

(a) the longitudinal extent of the step or recess, measured from the plane of the main transverse bulkhead, is not more than 3.0 metres, or:

(b) any longitudinal surface forming the step or recess is located inboard of the assumed damage.

Where, otherwise, the transverse and longitudinal bulkheads bounding a main inboard compartment are entirely in board of the assumed damage position, damage is assumed to occur between the transverse bulkheads of the adjacent wing compartment. Any step or recess in such wing tank shall be treated as indicated above.

Representative examples to clarify treatment of steps within the transverse extent of damage

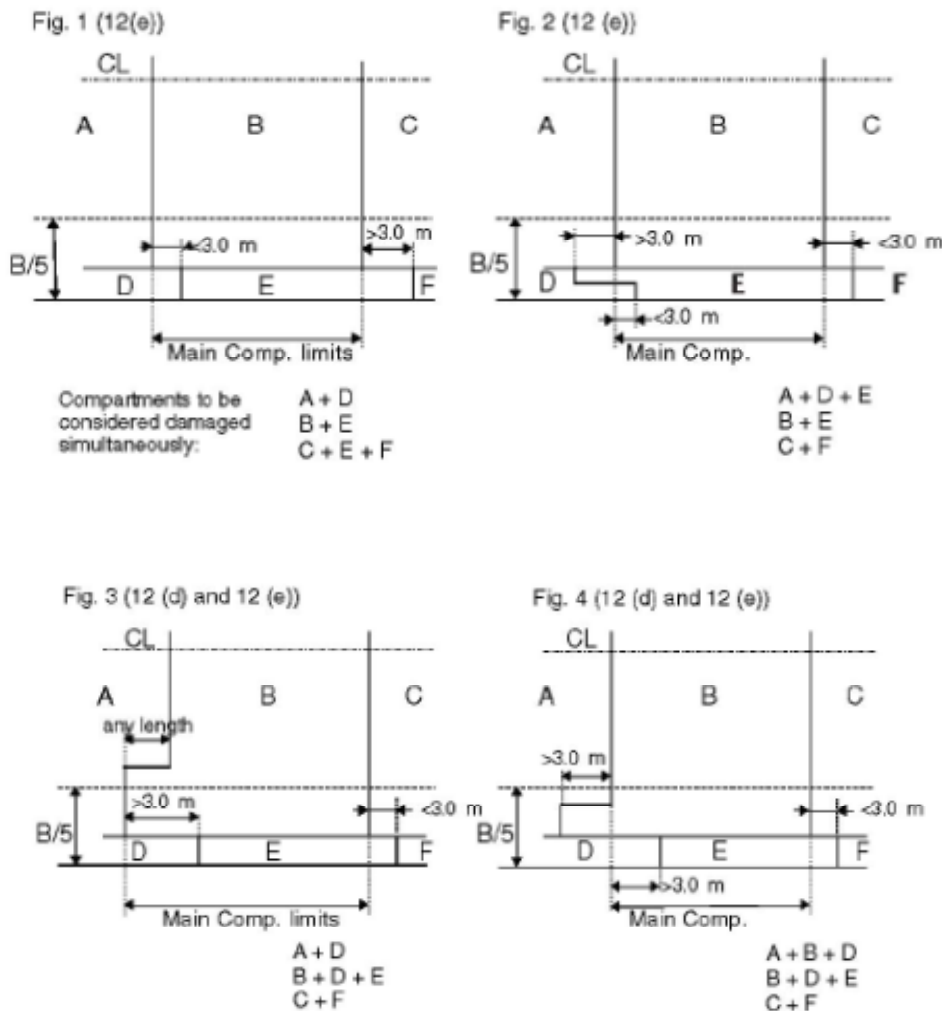

Notes:

1. This UI shall be uniformly implemented by all IACS Members and Associates to ships contracted for construction after 1 January 1999.
2. The “contracted for construction” date means the date on which the contract to build the vessel is signed between the prospective owner and the shipbuilder. For further details regarding the date of “contract for construction”, refer to IACS Procedural Requirement (PR) No. 29.
3. Longitudinal distance of 3.0(m) referred in sub-item (a) and figures 1 to 4 should be replaced with 3.05(m), when this interpretation applies to Res. A.320.

Footnote: This UI is also applicable to Regulation 27(12)(d) and (e) of the 1988 Protocol.

LL**64**

(December 1998)
 (Rev.1, March 1999)
 (Rev.2 June 2000)
 (Rev.3 July 2001)
 (Rev.4 July 2005)
 (Rev.5 July 2008)

Non-weathertight hatch covers above superstructure deck (Load Line Convention 1966 Regulations 2(5) and 14(2))

The requirements for coaming height and weathertightness of hatch covers located above the superstructure deck are left to the satisfaction of the flag Administration by Regulations 2(5) and 14(2) of the Load Line Convention. Exposed coamings and hatch covers situated above the second tier of the superstructure, or equivalent, or above the third tier, or equivalent, in the forward quarter of the ship's length, may be regarded to be above the superstructure deck in the application of 14(2). Non-weathertight covers in these locations may be accepted subject to the approval of the flag Administration and conditional upon the following:

1. Their acceptance should be limited to use on container ships.
2. They may be fitted to hatchways located on weatherdecks which are at least two standard superstructure heights above an actual freeboard deck or an assumed freeboard deck from which a freeboard can be calculated which will result in a draught not less than that corresponding to the freeboard actually assigned. Where any part of a hatchway is forward of a point located one quarter of the ship's length (0.25L) from the forward perpendicular, that hatchway is to be located on a weatherdeck at least three standard superstructure heights above the actual or assumed freeboard deck. It is to be noted that the assumed freeboard deck is used only for the purpose of measuring the height of the deck on which the hatchways are situated and may be an imaginary, or virtual deck and in this case is not to be used for the actual assignment of freeboard. The vessel's freeboard is to be assigned from an actual deck, designated as the freeboard deck, which is to be determined in accordance with the Convention and LL39.
3. The hatchway coamings should be not less than 600 mm in height.
4. The non-weathertight gaps between hatch cover panels should be considered as unprotected openings with respect to the requirements of intact and damage stability calculations. They should be as small as possible commensurate with the capacity of the bilge system and expected water ingress, and the capacity and operational effectiveness of the fire-fighting system and, generally, should not exceed 50 mm.
5. Labyrinths, gutter bars, or equivalents should be fitted proximate to the edges of each panel in way of the gaps to minimise the amount of water that can enter the container hold from the top surface of each panel.
6. Scantlings of the hatch cover panels are to be equivalent to those for weathertight covers and in accordance with the applicable requirements of UR S21 and UI LL70. The details on the securing arrangements to the vessel's support structure and coamings are provided in IACS Recommendation No. 14.
7. Bilge alarms should be provided in each hold fitted with non-weathertight covers.

Notes:

1. This Unified Interpretation is to be uniformly implemented by all Members and Associates from 1 July 1999, unless otherwise instructed by a Flag State.
 2. Changes introduced in Rev.3 are to be uniformly implemented by IACS Members and Associates from 1 January 2002.
 3. Changes introduced in Rev.4 are to be uniformly implemented by IACS Members and Associate from 1 January 2006.
- Footnote: This UI is also applicable to Regulations 2(5) and 14(2) of the 1988 Protocol and the revised 1988 Protocol.

LL**65**

(June 2000)
 (Rev.1 June 2007)
 (Rev.2 July 2008)

Ships with assigned or reassigned reduced freeboards and intended to carry deck cargo

(SOLAS, Chapter II-1, Regulation 4, footnotes .6 and .7)

"Cargo ships shown to comply with the following regulations may be excluded from the application of part B-1:

- .6 Damage stability requirements of regulation 27 of the 1966 Load Lines Convention as applied in compliance with resolutions A.320(IX) and A.514(13), provided that in the case of cargo ships to which regulation 27(9) applies, main transverse watertight bulkheads, to be considered effective, are spaced according to paragraph (12)(f) of resolution A.320(IX), except ships intended for the carriage of deck cargo; and*
- .7 Damage stability requirements of regulation 27 of the 1988 Load Lines Protocol, except ships intended for the carriage of deck cargo".*

General:

1. This UI pertains to ships intended to carry deck cargo and assigned or reassigned reduced freeboards in accordance with Regulation 27 of the International Convention on Load Lines, 1966 (ICLL 1966) or the ICLL 1966 as amended by the 1988 Protocol.
2. In .6 and .7 of the footnotes to SOLAS Chapter II-1, Regulation 4, ships shown to comply with ICLL 1966 Regulation 27 as applied in compliance with IMO Res. A.320 and A.514, may be excluded from the application of SOLAS Chapter II-1 Part B-1, except if they carry deck cargo.
3. Therefore ships identified in item 1), above, shall:

- a) according to the assigned reduced freeboards, comply with damage stability requirements of Regulation 27 of ICLL 1966 and the 1988 Protocol to the ICLL 1966; and
- b) according to the intended deck cargo capacity, be provided with the limiting GM or KG curve required by SOLAS Chapter II-1, Regulation 5-1.4 in compliance with the probabilistic damage stability analysis of SOLAS Chapter II-1 Part B-1.
4. The KG used for demonstrating compliance with the criteria in 3 a) shall be the same as that used for the criteria in 3 b) at the deepest subdivision load line.

Notes:

1. This UI LL 65 is to be uniformly implemented by IACS Members and Associates from 1 July 2001.
2. Revision 1 is to be uniformly implemented by IACS Members and Associates from 1 January 2009.

Footnote: This UI is also applicable to the revised 1988 Protocol.

LL

66

(Oct 2003)

Hatch Cover Stress/Deflection Calculation (Res. MSC.143(77), 2005 LL Protocol Regulation 16(5) (a) & (b))

Regulation 16 Hatchways closed by weathertight covers of steel or other equivalent materials

Hatch cover minimum design loads

(5) All hatch covers shall be designed such that:

- (a) the product of the maximum stress determined in accordance with the above loads and the factor of 1.25 does not exceed the minimum upper yield point strength of the material in tension and the critical buckling strength in compression;
- (b) the deflection is limited to not more than 0.0056 times the span,

Interpretation

In the calculation of stress and deflection from the prescribed mass per unit area, the design pressure is to be determined by using a vertical acceleration equal to 1.0g.

Note: This UI LL 66 is to be uniformly implemented by IACS Members and Associates from 1 January 2005.

LL

67

(Nov 2003)

(Rev.1, Nov 2005)

Endorsement of Certificates with the Date of Completion of the Survey on which they are Based

"Resolutions MSC.170(79), MSC.171(79), MSC.172(79), MSC.174(79) through MSC.179(79) and MSC.181(79) through MSC.187(79) require that the identified certificates include the statement:

"Completion date of the survey on which this certificate is based: dd/mm/yyyy".

Interpretation

For application of the above resolutions, the following IACS Unified Interpretation applies:

The "Completion date of the survey on which this certificate is based", is the date of the last **initial/renewal** survey visit on which all statutory and class items, required to be surveyed, have been surveyed (regardless if they were found satisfactory or with minor deficiency).

Note:

1. This UI is to be uniformly implemented by IACS Members and Associates from 1 March 2004.
2. Revision 1 of this UI is to be uniformly implemented by IACS Members and Associates from 1 July 2006.

LL

68

(May 2004)

(Rev.1 July 2008)

Position of Freeboard Deck on Float On/Float Off Barge Carriers (Regulation 3(9))

Reg.3(9):

"Freeboard Deck. The freeboard deck is normally the uppermost complete deck exposed to weather and sea, which has permanent means of closing all openings in the weather part thereof, and below which all openings in the sides of the ship are fitted with permanent means of watertight closing. In a ship having a discontinuous freeboard deck, the lowest line of the exposed deck and the continuation of that line parallel to the upper part of the deck is taken as the freeboard deck. At the option of the owner and subject to the approval of the Administration, a lower deck may be designated as the freeboard deck provided it is a complete and permanent deck continuous in fore and aft direction at least between the machinery space and peak bulkheads and continuous athwartships. When this lower deck is stepped the lowest line of the deck and the continuation of that line parallel to the upper part of the deck is taken as the freeboard deck. When a lower deck is designated as the freeboard deck, that part of the hull which extends above the freeboard deck is treated as a superstructure so far as concerns the application of the conditions of assignment and the calculation of freeboard. It is from this deck that the freeboard is calculated."

Interpretation:

1. Float On/Float Off Barge Carriers are designed to be ballasted such that the bottom of their cargo space(s) (well deck) submerges below the waterline to allow barges being floated in and out.
2. If such a ship is fitted with weathertight closures for the cargo space(s) and a watertight enclosure at the stern, the uppermost complete deck may be taken as the freeboard deck.
3. If such a ship is not fitted with weathertight closures for the cargo space(s) or a watertight enclosure at the stern, the well deck shall be taken as the freeboard deck, while buoyant spaces above may be considered as superstructures in accordance with UI LL 15 or 88 Prot. Reg. 34(1).
4. If such a ship is not fitted with weathertight closures for the cargo space(s) but has a watertight enclosure at the stern, the uppermost complete deck may be taken as the freeboard deck provided that:
 - the structure of the freeboard deck complies with the requirements of LL39;
 - the calculated freeboard is corrected for any missing buoyancy above the well deck in accordance with LL48, and
 - a satisfactory safety level at the resulting draught is demonstrated according to alternative concepts.

Note: This UI is to be uniformly implemented by IACS Members and Associates from 1 April 2005.

Footnote: This UI is also applicable to Regulation 3(9) of the 1988 Protocol and the revised 1988 Protocol.

LL**69**

(May 2004)

(Rev.1 July 2008)

Interpretation to 1966 ICLL Reg. 27**Reg.27 of ICLL 1966: IMO Res. A.320 paragraph 12:****“Damage Assumptions**

(12) The following principles regarding the character of the assumed damage apply:

- (a) The vertical extent of damage in all cases is assumed to be from the base line upwards without limit.
- (b) The transverse extent of damage is equal to B/5 or 11.5 metres (37.7 feet), which ever is the lesser, measured inboard from the side of the ship perpendicularly to the centre line at the level of the summer load water line.
- (c) If damage of a lesser extent than specified in sub paragraphs (a) and (b) of this paragraph results in a more severe condition, such lesser extent shall be assumed.
- (d) Except where otherwise required by paragraph (10)(a) the flooding shall be confined to a single compartment between adjacent transverse bulkheads provided the inner longitudinal boundary of the compartment is not in a position within the transverse extent of assumed damage. Transverse boundary bulkheads of wing tanks, which do not extend over the full breadth of the ship shall be assumed not to be damaged, provided they extend beyond the transverse extent of assumed damage prescribed in sub paragraph (b) of this paragraph.

If in a transverse bulkhead there are steps or recesses of not more than 3.05 metres (10 feet) in length located within the transverse extent of assumed damage as defined in sub-paragraph (b) of this paragraph, such transverse bulkhead may be considered intact and the adjacent compartment may be floodable singly. If, however, within the transverse extent of assumed damage there is a step or recess of more than 3.05 metres (10 feet) in length in a transverse bulkhead, the two compartments adjacent to this bulkhead shall be considered as flooded. The step formed by the after peak bulkhead and the after peak tank top shall not be regarded as a step for the purpose of this Regulation.

(e) Where a main transverse bulkhead is located within the transverse extent of assumed damage and is stepped in way of a double bottom or side tank by more than 3.05 metres (10 feet), the double bottom or side tanks adjacent to the stepped portion of the main transverse bulkhead shall be considered as flooded simultaneously. If this side tank has openings into one or several holds, such as grain feeding holes, such hold or holds shall be considered as flooded simultaneously. Similarly in a ship designed for the carriage of fluid cargoes, if a side tank has openings into adjacent compartments, such adjacent compartments shall be considered as empty and flooded simultaneously. This provision is applicable even where such openings are fitted with closing appliances, except in the case of sluice valves fitted in bulkheads between tanks and where the valves are controlled from the deck. Manhole covers with closely spaced belts are considered equivalent to the unpierced bulkhead except in the case of openings in topside tanks making the topside tanks common to the holds.

(f) Where the flooding of any two adjacent fore and aft compartments is envisaged main transverse watertight bulkheads shall be spaced at least $1/3L/3$ or 14.5 metres (0.495L/3 or 47.6 feet), whichever is the lesser, in order to be considered effective. Where transverse bulkheads are spaced at a lesser distance, one or more of these bulkheads shall be assumed as non-existent in order to achieve the minimum spacing between bulkheads.”

Interpretation:

Treatment of the volume of the forecastle, which is located over the foremost cargo hold for damage stability calculation in accordance with Reg.27 of ICLL 1966: IMO Res. A.320 paragraph 12.

In the case where the forecastle overlaps foremost cargo hold, provided the forecastle bulkhead is not more than 3.05 m aft of the forward bulkhead of the hold and the deck forming the step in way is watertight, then the bulkhead will be considered as continuous and not subject to damage.

Notes:

1. This UI is to be uniformly implemented by IACS Members and Associates from 1 April 2005.
2. The distance of 3.05 m referred in this UI should be replaced with 3.00 m, when this interpretation applies to the 1988 Protocol and the revised 1988 Protocol.

LL**70**

(Jan 2005)

Corrosion Margin for Hatch Cover Design**Reg. 16 (5)(d), amendments to the Protocol of 1988 relating to the International Convention on Load Lines, 1966 (Res. MSC. 143(77))****Regulation 16 (5) (d) reads:****Hatchways closed by weathertight covers of steel or other equivalent material**

All hatch covers shall be designed such that:

- (a) the product of the maximum stress determined in accordance with the above loads and the factor of 1.25 does not exceed the minimum upper yield point strength of the material in tension and the critical buckling strength in compression;
- (b) the deflection is limited to not more than 0.0056 times the span;
- (c) steel plating forming the tops of covers is not less in thickness than 1% of the spacing of stiffeners or 6 mm if that be greater; and
- (d) an appropriate corrosion margin is incorporated.

InterpretationThe "appropriate corrosion margin" for hatch covers of cargo holds in position 1 and 2 and above, defined as the corrosion addition t_s which is to be added to the net thickness t_{net} required by (a), (b) and (c) is:

1. for Bulk Carriers, Ore Carriers and Combination Carriers, as defined in UR Z11.2:

- single skin hatch covers, a corrosion addition $t_s = 2.0$ mm for all plating and stiffeners;
- double skin hatch covers, a corrosion addition $t_s = 2.0$ mm for top and bottom plating and $t_s = 1.5$ mm for the internal structure.

2. for other vessels:

- single skin hatch covers, a corrosion addition $t_s = 2.0i$ mm for all plating and stiffeners;
- double skin hatch covers, a corrosion addition $t_s = 1.5i$ mm for top and bottom plating and $t_s = 1.0$ mm for the internal structure.

i) Corrosion addition $t_s = 1.0$ mm for the hatch covers in way of cellular cargo holds intended for containers.

The above corrosion margins have been defined based on the assumption that corrosion protection and renewals as given in UR S21.6.1 is complied with for all ship types subject to regulation 16 (5) (d) of the 1988 Load Line Protocol.

For corrosion addition $t_s = 1.0$ mm it is assumed that the thickness for steel renewal is t_{net} and the thickness for coating or annual gauging is $t_{net} + 0,5$ mm.

Note: This UI LL70 is to be uniformly implemented by IACS Members and Associates on ships constructed (i.e. keel laid) from 1st January 2005.

LL**71**

(April 2005)

(Rev.1 July 2008)

Similar stage of construction**(1966 ILLC, Article 2(6))****(amended LL Protocol 1988, regulation 2, paragraphs (7) and (8))****1966 ILLC, Article 2(6):**

New ship means a ship the keel of which is laid, or which is at a similar stage of construction, on or after the date of coming into force of the present Convention for each Contracting Government.

Amended 1988 LL Protocol, regulation 2, paragraphs (7) and (8):

(7) Unless expressly provided otherwise, the regulations of this Annex shall apply to ships the keels of which are laid or which are at a similar stage of construction on or after 1 January 2005.

(8) For ships the keels of which are laid or which are at a similar stage of construction before 1 January 2005, the Administration shall ensure that the requirements which are applicable under the International Convention on Load Lines, 1966, as modified by the Protocol of 1988 relating thereto, adopted by the International Conference on Harmonized System of Survey and Certification, 1988, are complied with.

Interpretation:

The term "similar stage of construction" means the stage at which:

- construction identifiable with a specific ship begins; and
- assembly of that ship has commenced comprising at least 50 tonnes or one per cent of the estimated mass of all structural material, whichever is less.

Note: This UI LL71 is to be uniformly implemented by IACS Members and Associate from 1 July 2005.

Footnote: This UI is also applicable to Article 2(6) of the 1988 Protocol and the revised 1988 Protocol.

LL**72**

(Sept 2005)

Interpretation to ICLL Regulation 27**Regulation**

Regulation 27(3) reads:

A type "A" ship, if over 150 m in length, and designed to have empty compartments when loaded to her summer load water line, shall be able to withstand the flooding of any one of these empty compartments at an assumed permeability of 0.95, and remain afloat in a condition of equilibrium considered to be satisfactory by the Administration.

In such a ship, if over 225 m in length, the machinery space shall be treated as a floodable compartment but with a permeability of 0,85.

Interpretation

Members apply resolution A.320(IX) when certifying ships of non 1988 Protocol Parties under regulations 27(3) of the 1966 ICCL.

Note:

This UI is to be uniformly implemented by IACS Members and Associates to ships constructed on or after 1 January 2006.

LL**74**

(Aug 2008)

Measurement of Distances

Several IMO instruments (e.g., ICLL, SOLAS and MARPOL Conventions, the IBC Code and the IGC Code, etc.) require distances to be measured such as tank length, height, width, ship (or subdivision or waterline) length, etc..

Interpretation

Unless explicitly stipulated otherwise in the text of the regulations in SOLAS, Load Line and MARPOL Conventions and any of their mandatory Codes, distances are to be measured by using moulded dimensions.

Note:

This Unified Interpretation is to be uniformly implemented by IACS Societies from 1 April 2009.

LL**75**

(Sept 2008)

(Rev.1 Mar 2009)

Permeability of Store Space in the Damage Stability Calculation (Regulation 27(3) & (8.d))**Regulation**

1. Reg.27(3) of 1988 protocol of 1966 ICLL and its amendment MSC.143(77) reads:

"(3) A type 'A' ship, if over 150 m in length, to which a freeboard less than type 'B' has been assigned, when loaded in accordance with the requirements of paragraph (11), shall be able to withstand the flooding of any compartment or compartments, with an assumed permeability of 0.95, consequent upon the damage assumptions specified in paragraph (12), and shall remain afloat in a satisfactory condition of equilibrium, as specified in paragraph (13). In such a ship, the machinery space shall be treated as a floodable compartment, but with a permeability of 0.85."

2. Reg.27(8.d) of 1988 protocol of 1966 ICLL and its amendment MSC.143(77) reads:

"the ship, when loaded in accordance with the requirements of paragraph (11), shall be able to withstand the flooding of any compartment or compartments, with an assumed permeability of 0.95, consequent upon the damage assumptions specified in paragraph (12), and shall remain afloat in a satisfactory condition of equilibrium, as specified in paragraph (13). In such a ship, if over 150 m in length, the machinery space shall be treated as a floodable compartment, but with a permeability of 0.85."

Interpretation

The permeability assumed in the damage stability calculation for the flooding of any store space shall be 0.95 under 1988 Protocol of 1966 ICLL.

Note:

1. This Unified Interpretation is to be uniformly implemented by IACS Members and Associates for ships contracted for construction on or after 1 July 2009.

2. The "contracted for construction" date means the date on which the contract to build the vessel is signed between the prospective owner and the shipbuilder. For further details regarding the date of "contract for construction", refer to IACS Procedural Requirement (PR) No. 29.

LL**77**

(Dec 2011)

Application of Load Line Requirements to Conversions of Single-hull Oil Tankers to Double-hull Oil Tankers or Bulk Carriers**Article 10 - Repairs, alterations and modifications**

(1) *A ship which undergoes repairs, alterations, modifications and outfitting related thereto shall continue to comply with at least the requirements previously applicable to the ship. An existing ship in such a case shall not, as a rule, comply to a lesser extent with the requirements for a new ship than it did before.*

(2) *Repairs, alterations and modifications of a major character and outfitting related thereto should meet the requirements for a new ship in so far as the administration deems reasonable and practicable.*

Interpretation

1 For single-hull oil tankers converted to double-hull oil tankers:

1.1 The ship should meet the requirements of the regulations contained in chapter III (Freeboards) of Annex I of the Load Line Convention in effect at the date of conversion. In cases where there are no changes to the parameters which result in a change of the minimum freeboard¹, and where there is no decrease in magnitude of freeboard assigned after conversion, using the Convention previously applicable to the ship in determining any change or decrease as mentioned above, the converted ship should continue to comply with at least the requirements previously applicable to the ship.

1.2 Any structure and/or equipment such as doors, hatches, and cable lockers, etc., which is newly added, replaced, or modified is to comply with the requirements of the regulations contained in chapter II (Conditions of assignment of freeboard) of Annex I of the Convention in effect at the date of conversion.

2 For single-hull oil tankers converted to bulk carriers:

2.1 Any such conversion should be regarded as a modification of a major character and the ship should meet all the requirements of the regulations annexed to the Convention (including regulation 39) in effect at the date of conversion; and

2.2 Notwithstanding the above, the requirements of the regulations contained in chapter II (Conditions of assignment of freeboard) of Annex I of the Convention in effect at the date of conversion, should be applied only to the structure and/or equipment, which is newly added, replaced, or modified.

3 The date on which a conversion occurs for the purposes of determining the applicability of requirements for ships constructed on or after the date on which any relevant amendments enters into force should be:

3.1 the date on which the contract is placed for the conversion; or

3.2 in the absence of a contract, the date on which the work identifiable with the specific conversion begins; or

3.3 the completion date of the conversion², if that occurs more than 3 years after the date specified in subparagraph 3.1 above or 30 months after the date specified in subparagraph

3.2 above, either as applicable.

Footnote:

¹ "which result in a change of the minimum freeboard" should be understood as "which are used in determining the minimum freeboard even though the minimum freeboard has no change in fact".

² Where the completion date of the conversion has been subject to delay beyond the period referred to in paragraph 3.3 above due to unforeseen circumstances beyond the control of the builder and the owner, the other dates referred to in paragraph 3.1 or 3.2 above, if applicable, may be accepted by the Administration in lieu of the completion date of the conversion in accordance with MSC-MEPC.1/Circ.1247.